

MAR301 series

AIR UNIT (R.UNIT)

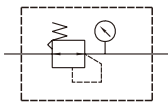

Symbol



Specification

Model	MAR301	
Bore No.	8A	10A
Port size	1/4	3/8
Medium	Air	
Max. operating pressure	1 MPa	
Proof pressure	1.5 MPa	
Regulated pressure range	0.05~0.85 MPa	
Ambient temperature	-5~+60°C (No freezing)	
Attachment	L type bracket	
Option	Pressure gauge (PG-40)	
Weight	250 g	

Order example

MAR301 — 8A — C — □ — □

MODEL

PORT SIZE

8A: 1/4
10A: 3/8

BRACKET

Blank: L type
B3: Z type

PORT THREAD

Blank: Rc thread
G: G thread
NPT: NPT thread

C: Pressure gauge (PG-40)

Flow feature

8A

Primary pressure 0.7 MPa

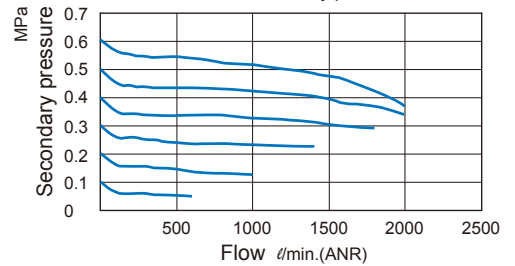

10A

Primary pressure 0.7 MPa

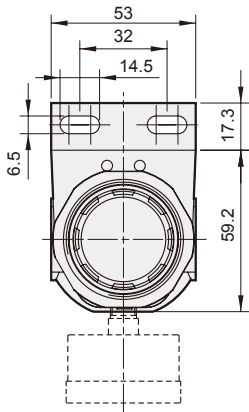
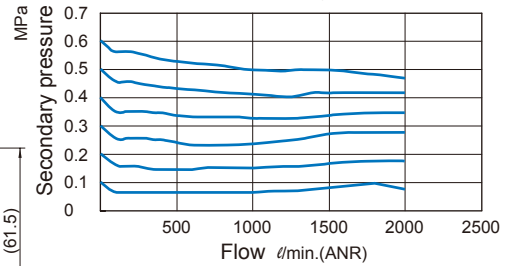

Panel mounting hole

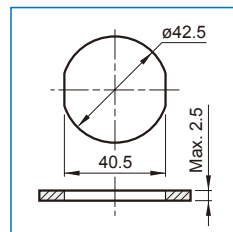

Z type bracket

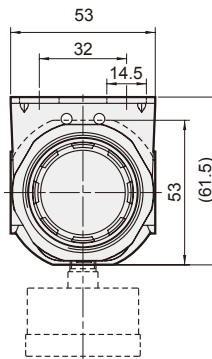
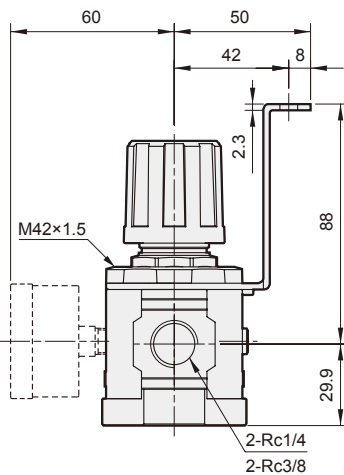

L type bracket

