

Specification

- DC24V
- 25 Pin D-sub connector (cable length 3m).
- Simple electric wire system.

Remark

- MVB-300, 460 series is available in 3-station~12-station manifold.
- Individual manifold can be ordered. EX: MVB-220-5B5-G.
- Maximum number of stations for MVB-200 series is 16 and please contact sales people before ordering.
- Please contact us for the manifold for 3/2 valves.

Valves assembled

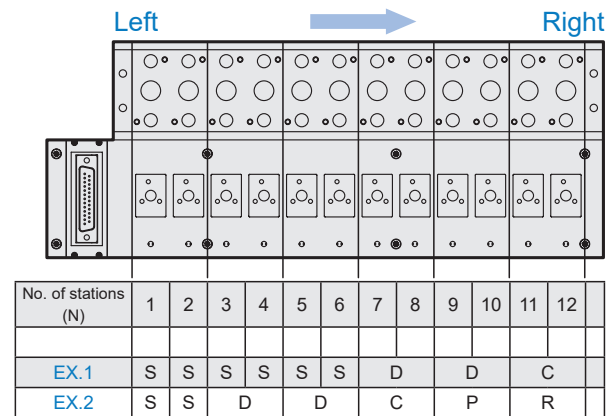

Order example (Multi connector system)

MVB - 220 - 5B6 - SSSDC - G

MODEL

BODY WIDTH

220: for MVSC-220 series
300: for MVSC-300 series
460: for MVSC-460 series

MANIFOLD NUMBER
2, 3, 4..., 12

PORT THREAD

Blank: Rc thread
G: G thread
NPT: NPT thread

MANIFOLD

3B: 3 port (for body ported type)
5B: 5 port (for body ported type)

SOLENOID VALVE (for 5B)

S	4E1: 5/2 Single solenoid
D	4E2: 5/2 Double solenoid
C	4E2C: 5/3 Double solenoid
P	4E2P: 5/3 Double solenoid
R	4E2R: 5/3 Double solenoid
B	Blocking plate

* EX.1 5B12-SSSSSSDDC

* EX.2 5B12-SSDDCPR

SOLENOID VALVE (for 3B)

C	3E1-NC: 3/2 Single solenoid / Normally closed
O	3E1-NO: 3/2 Single solenoid / Normally open
D	3E2: 3/2 Double solenoid
B	Blocking plate

* Every double solenoid valve requires 2 stations on the manifold.
(One is for the valve and another is for the adapter)

* Valves are assembled from the D-sub side.

Order example (Solenoid valve)

MVSC - 220 - 4E2C - DC24 - N - G

MODEL

BODY WIDTH

220
300
460

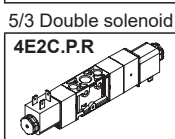
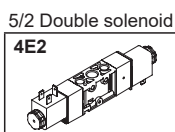
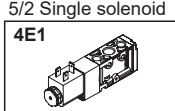

3/2 Single solenoid/
Normally closed

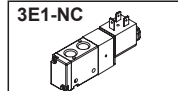

3/2 Single solenoid/
Normally open

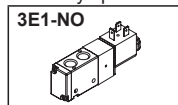

3/2 Double solenoid

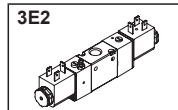

VOLTAGE

N: No connector

PORT THREAD

Blank: Rc thread
G: G thread
NPT: NPT thread

Order example of cable

MVB - 100 - D

* Use the same cable with MVB-100.

D-SUB CABLE

Order example (Adapter for a double solenoid valve)

MVB – 220 – 5T

MODEL

BODY WIDTH

3T: Adapter for a 3-port double solenoid valves.
5T: Adapter for a 5-port double solenoid valves.

220: for MVSC-220 series
300: for MVSC-300 series
460: for MVSC-460 series

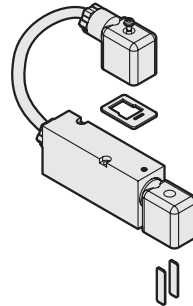

Gasket for connector × 1

Connector × 1
(includes adapter)

Connection pin × 2

Ex

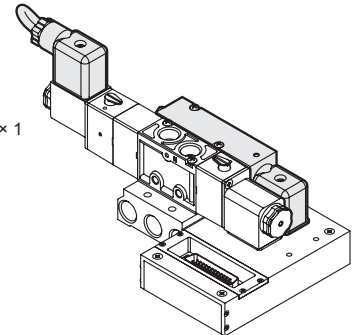

25 PIN

Wire color	Pin No.	Coil No.	
Brown	1	D-01	D-01
Brown / white	2	D-02	D-02
Red	3	D-03	D-03
Red / black	4	D-04	D-04
Orange	5	D-05	D-05
Orange / black	6	D-06	D-06
Yellow	7	D-07	D-07
Yellow / black	8	D-08	D-08
Green	9	D-09	D-09
Green / black	10	D-10	D-10
Blue	11	D-11	D-11
Blue / white	12	D-12	D-12
Purple / white	14	D-13	D-13
Gray	15	D-14	D-14
Gray / black	16	D-15	D-15
White	17	D-16	D-16
White / black	18	-	
Pink	19	-	
Pink / black	20	-	
White / red	21	-	
White / blue	22	-	
Light blue	23	-	
Light blue / black	24	-	
Purple	13	COM	COM
Light green	25	COM	COM

MVSC-220-4E2C.P.R
MVSC-300-4E2C.P.R
MVSC-460-4E2C.P.R

MVSC-220-4E2
MVSC-300-4E2
MVSC-460-4E2

MVSC-220-4E1
MVSC-300-4E1
MVSC-460-4E1

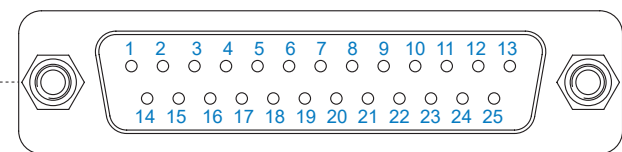

* Please shield the wires for unused pins to avoid abnormalities caused by short circuit.

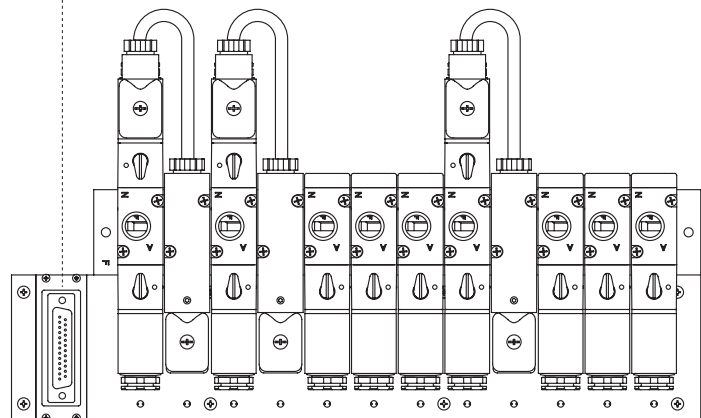

D-01 D.**

MVB-220 Dimensions

MULTI CONNECTOR SYSTEM



MVB-220-3B*

3 port (for body ported type)

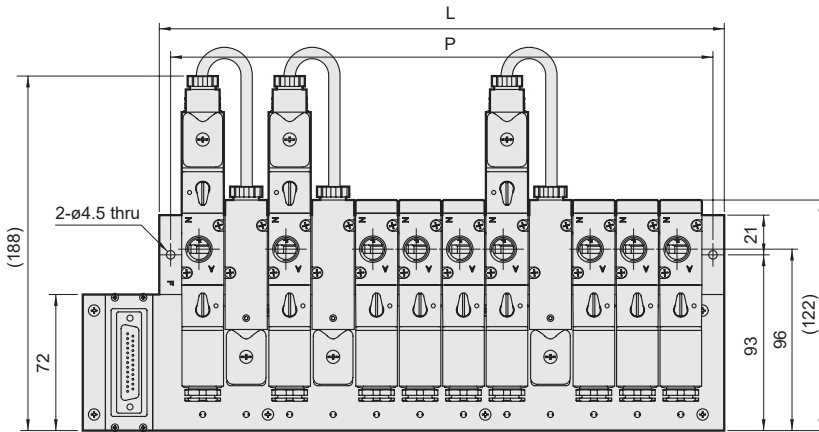

No. of stations	L	L1	P
2	69	109.5	57
3	92	132.5	80
4	115	155.5	103
5	138	178.5	126
6	161	201.5	149
7	184	224.5	172
8	207	247.5	195
9	230	270.5	218
10	253	293.5	241
11	276	316.5	264
12	299	339.5	287

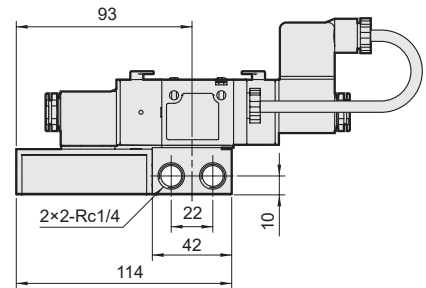
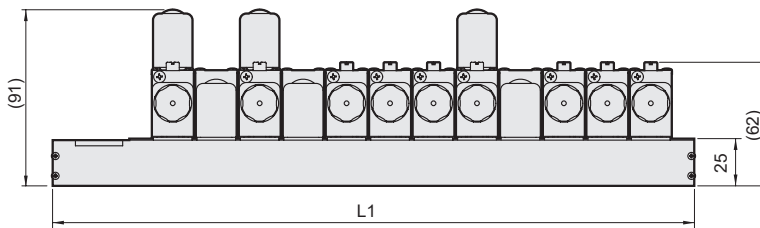

MVB-220-5B*

5 port (for body ported type)

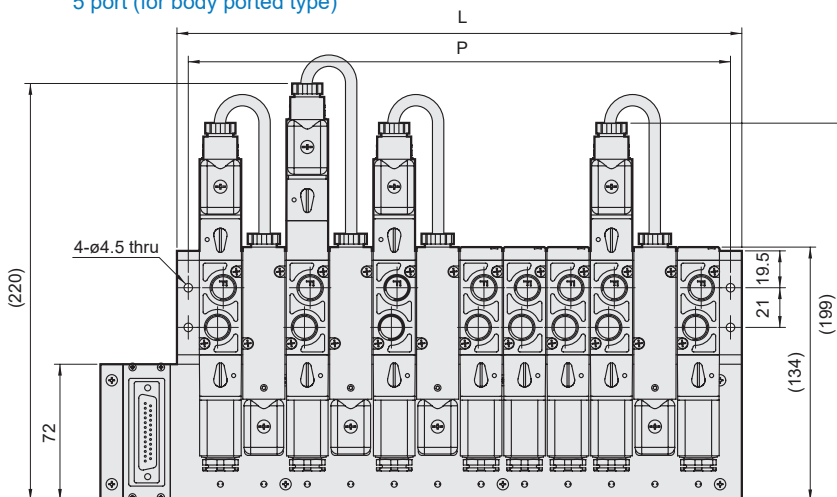

No. of stations	L	L1	P
2	69	109.5	57
3	92	132.5	80
4	115	155.5	103
5	138	178.5	126
6	161	201.5	149
7	184	224.5	172
8	207	247.5	195
9	230	270.5	218
10	253	293.5	241
11	276	316.5	264
12	299	339.5	287

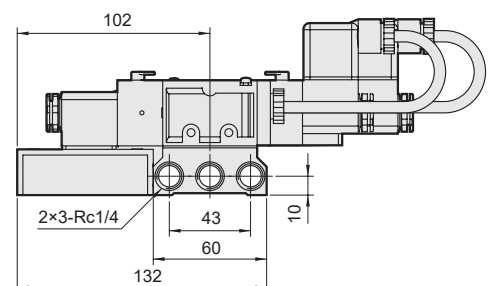
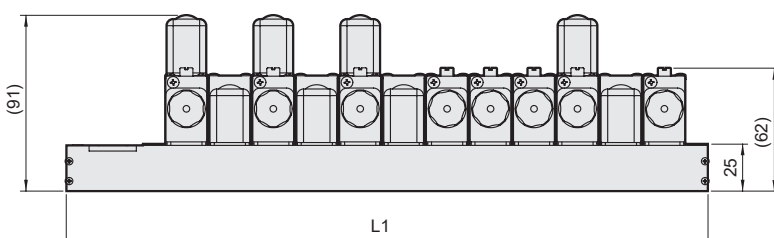

MVB-300 Dimensions

MULTI CONNECTOR SYSTEM



MVB-300-3B*

3 port (for body ported type)

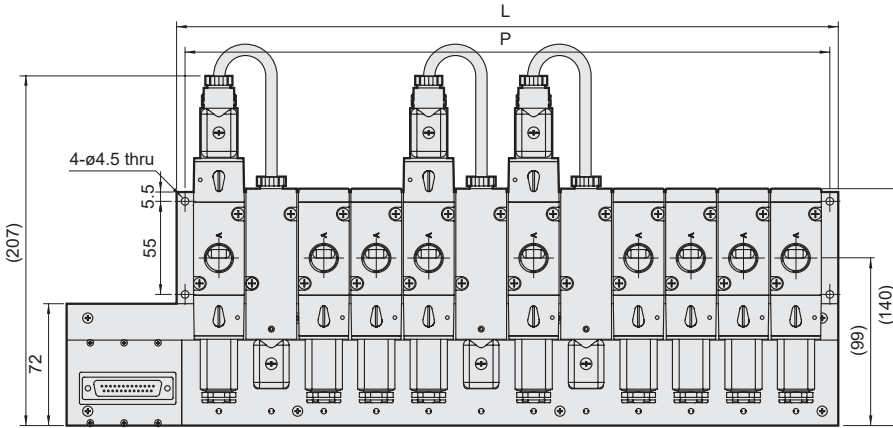

No. of stations	L	L1	P
3	112	177	102
4	143	208	133
5	174	239	164
6	205	270	195
7	236	301	226
8	267	332	257
9	298	363	288
10	329	394	319
11	360	425	350
12	391	456	381

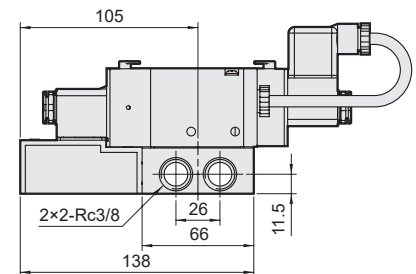
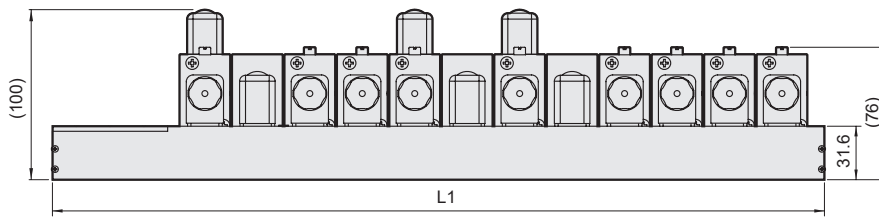

MVB-300-5B*

5 port (for body ported type)

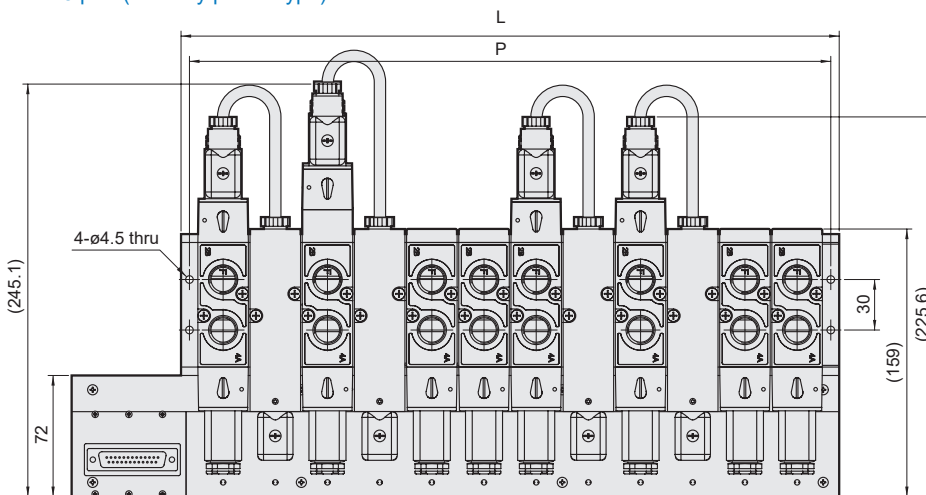

No. of stations	L	L1	P
3	112	177	102
4	143	208	133
5	174	239	164
6	205	270	195
7	236	301	226
8	267	332	257
9	298	363	288
10	329	394	319
11	360	425	350
12	391	456	381

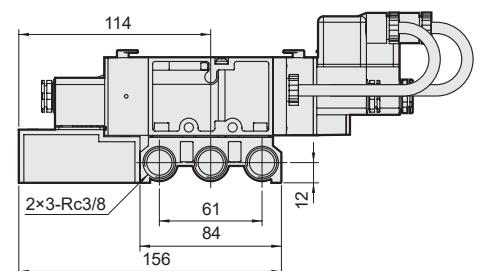
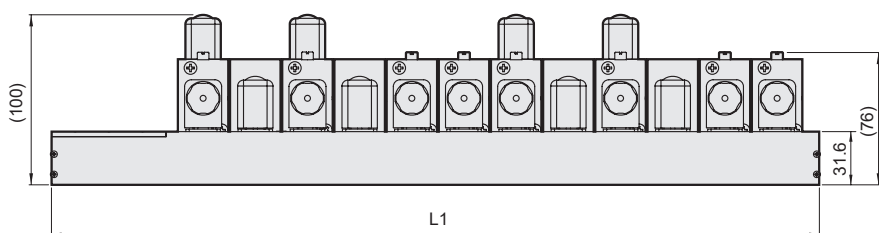

MVB-460 Dimensions

MULTI CONNECTOR SYSTEM



MVB-460-3B*

3 port (for body ported type)

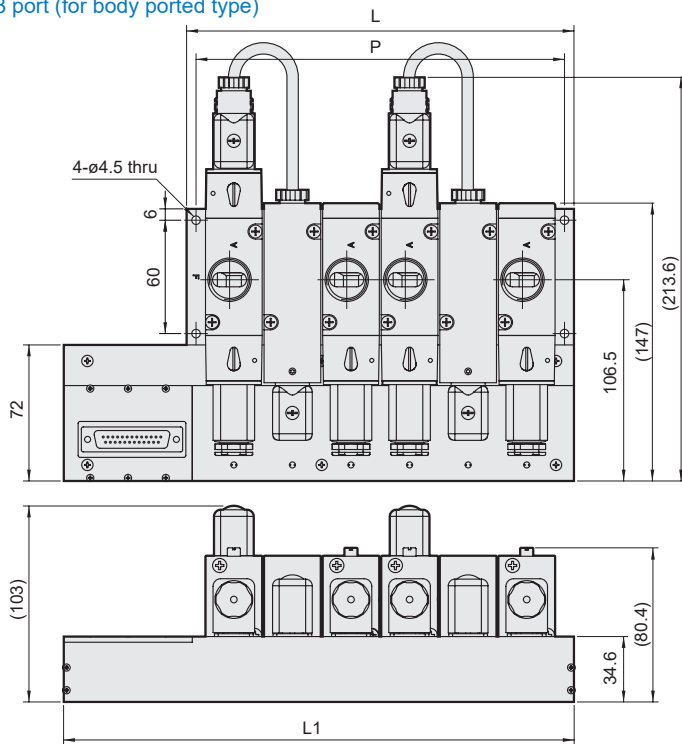

No. of stations	L	L1	P
3	112	177	102
4	143	208	133
5	174	239	164
6	205	270	195
7	236	301	226
8	267	332	257
9	298	363	288
10	329	394	319
11	360	425	350
12	391	456	381

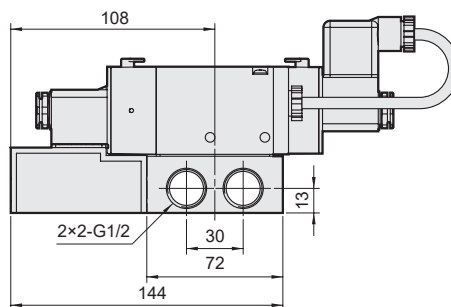

MVB-460-5B*

5 port (for body ported type)

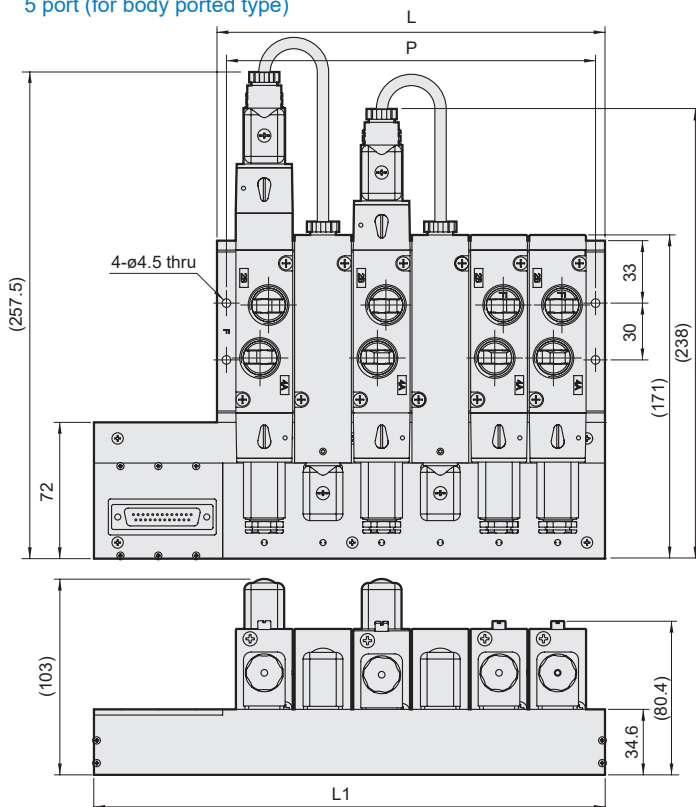

No. of stations	L	L1	P
3	112	177	102
4	143	208	133
5	174	239	164
6	205	270	195
7	236	301	226
8	267	332	257
9	298	363	288
10	329	394	319
11	360	425	350
12	391	456	381

