

# PNEUMATIC POWER CLAMPS

Pneumatic power clamps with compensation system, toggle-joint mechanism and stepless adjustable opening angle, typically used for handling and holding metal sheets in welding applications, including the most demanding aluminium welding applications, characterized by high magnetic fields and fine dust:

- Fully adjustable opening angle
- Electronic sensor with M12 swivel connector or pneumatic sensor
- Self-holding device for open position upon request
- ATEX version available

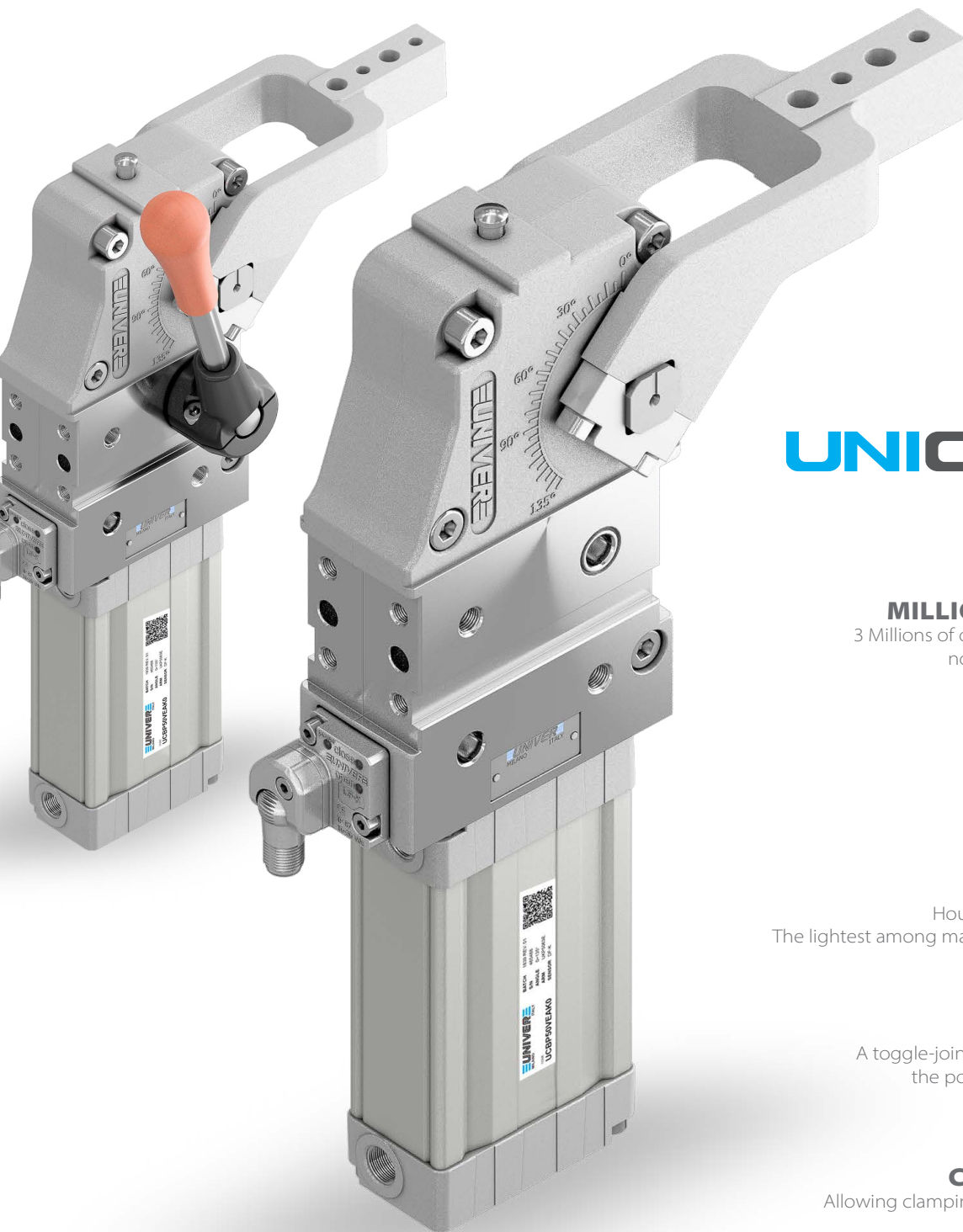

**UNICLAMP**  
next generation

## MILLIONS OF CYCLES

3 Millions of operations granted with no maintenance required



## QR CODE

Helps identify products quickly and easily



## LIGHTWEIGHT

Housing in aluminium alloy  
The lightest among market equivalent devices



## IRREVERSIBLE

A toggle-joint mechanism maintains the position even with air lack



## COMPENSATION

Allowing clamping of different thickness





## UNICLAMP<sup>®</sup>

next generation

Wide range of power clamps meeting the European standards, available in various versions:

- Pneumatic Ø 40 - 50 - 63 - 80 mm
- Pneumatic with hand lever Ø 40 - 50 - 63 - 80 mm
- Manual size 50 - 63 mm
- Double arm Ø 40 - 63 mm
- Fully protected version Ø 40 - 50 - 63 - 80 mm



GLOBAL STANDARD COMPONENTS

## NAAMS

Pneumatic power clamps meeting NAAMS standard (North American Automotive Metric Standard) available in both standard version and version with hand lever:

- Pneumatic Ø 50 - 63 - 80 mm
- Pneumatic with hand lever Ø 50 - 63 - 80 mm

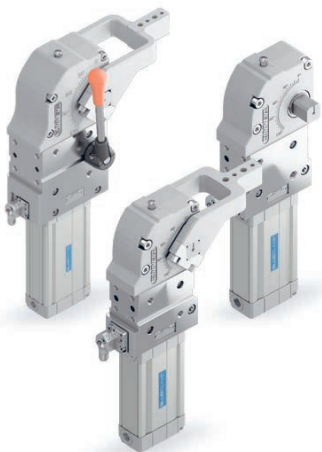

## BLUECLAMP

air saving

Air saving power clamps assuring a relevant reduction in air consumption without affecting the standard performances required from the market:

- Pneumatic size 32 - 40 - 50 - 63 - 80 mm
- Pneumatic with hand lever size 32 - 40 - 50 - 63 - 80 mm
- NAAMS Pneumatic size 50 - 63 - 80 mm
- NAAMS Pneumatic with hand lever size 50 - 63 - 80 mm

# POWER CLAMPS FEATURES

## ROLLER BEARINGS

Linear and rotary motion guided by roller bearings

## MANUAL RELEASE BUTTON

Safety unlocking system without air supply

## INTEGRATED COMPENSATION

Allows clamping of different thickness  
Up to **3 mm**

## TOGGLE-JOINT

Irreversible without external stops  
UNIVER Original

## OPTICAL SENSOR

High precision system  
No adjustment required

## SUPPLY PORTS ON BOTH SIDES

Calibrated holes

## SELF-ADJUSTING CUSHIONING SYSTEM

Special solution on piston rod  
allows flow regulation

## REDUCED DIMENSIONS

Compact end caps

## ANGLE ADJUSTMENT

Covers the whole range of possible  
opening angles

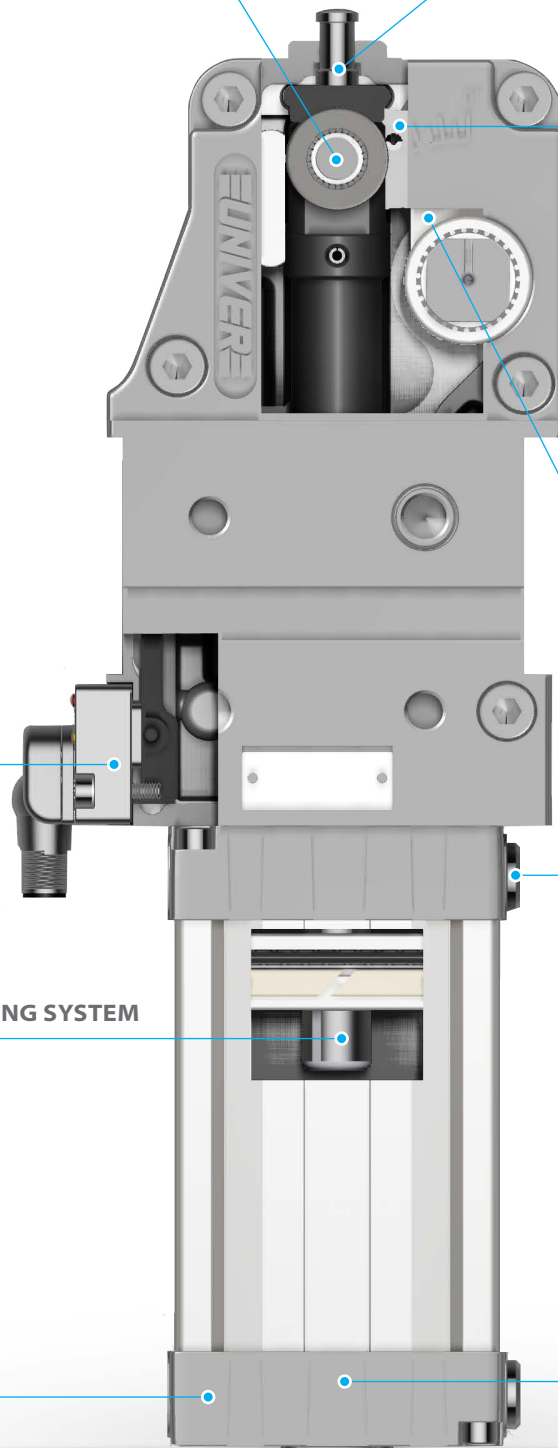

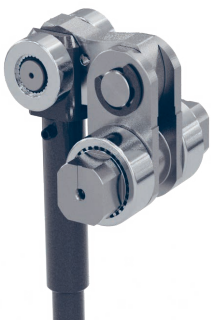
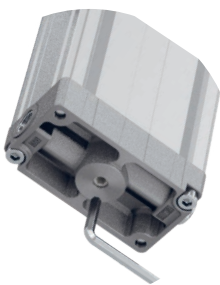
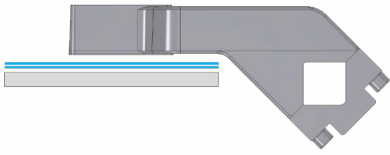

## INTEGRATED COMPENSATION

The original UNIVER integrated compensation system allows to compensate metal sheet thickness variations up to 3 mm

No need to modify the shims in case of clamping of different metal sheets inside the compensation range



## OPTICAL SENSOR

Fully metal body

One single sensor for the whole range of products

IP67 protection

M12 swivel connector (0-90°)

High precision

No set up

Two-parts design: electronic part outside the unit (available as spare part), optical part inside the unit (no touch point)

Insensitive to high magnetic fields, typical of new and modern welding systems like aluminium welding

Industry-recognized, tested and proven sensor



## ANGLE ADJUSTMENT 0°-135°

Stepless adjustment of the opening angle by means of a hex key from the bottom of the clamp

No need to set the sensor

Possibility to reduce the opening angle to the minimum required

One single device covers the whole range of opening angles aimed at stock reduction



## TOGGLE-JOINT MECHANISM

The original UNIVER toggle joint system allows the clamp to maintain the position even with lack of air without external stops

Position repeatability

No backlash in closed position

# COMPLEMENTARY PRODUCTS



## CLAMPING ARM

Aluminium or Steel  
Different offsets for each arm size  
NAAMS arms available upon request



## PNEUMATIC SENSOR

Compact design  
Fully metal body  
Easy to be replaced  
One-piece construction



## SELF HOLDING SYSTEM

UNIVER original  
Suitable for any opening angle  
Adjustable holding force



## HAND LEVER

Ergonomic design  
Welding debris resistant

# UCBP 80

Pneumatic power clamps Ø80 mm

Pneumatic power clamps with compensation system, toggle-joint mechanism and stepless adjustable opening angle, typically used for handling and holding metal sheets in welding applications

- Lightweight aluminium construction
- Integrated compensation system up to 2,9 mm
- Version with manual hand lever available
- Fully optical electronic sensor or pneumatic sensor
- Fixing pattern on 4 sides
- Manual unlocking in case of air loss
- Self-holding system for open position available
- Clamping arm in aluminium or steel



## CHARACTERISTICS

Operating temperature	5° ÷ 45° C
Min./Max. Operating pressure	0,4 / 0,6 MPa
Opening angle*	0° ÷ 135°
Bore Ø	80 mm
Holding moment	4000 Nm
Clamping moment (0,5 MPa)	1100 Nm
Weight (clamping arm not included)	8,6 Kg
Pneumatic supply ports	G1/4 on both sides
Sensor	electronic (optical)
Supply voltage	10 ÷ 30 Vdc
IP code	IP65

\*The opening angle range may vary according to the arm position and style.

## CODIFICATION KEY

UC	B	P	80	O	E	A	K	0	
1	2	3	4	5	6	7	8	9	10



COMPENSATION



LIGHTWEIGHT





IRREVERSIBLE



ANGLE ADJUSTMENT



OPTICAL SENSOR

<b>1</b> SERIES UC = UNICLAMP Power clamps	<b>6</b> ARM STYLE C = Central, 20 mm offset D = Right, 20 mm offset S = Left, 20 mm offset E = Central, 45 mm offset F = Right, 45 mm offset L = Left, 45 mm offset N = No arm For other versions contact our Sales Dept.
<b>2</b> STANDARD B = European standard	<b>7</b> ARM TYPE A = Aluminium S = Steel N = No arm
<b>3</b> VERSION P = Pneumatic	<b>8</b> SENSOR N = No sensor (with protection plate) K = Electronic sensor PNP, M12 (DF-K) D = Pneumatic sensor (DF-UPNW80) J = Electronic sensor NPN, optical (DF-J) Y = Electronic sensor PNP, M12 (DF-Y) white LED
<b>4</b> SIZE 80 = Ø80 mm	<b>9</b> PRODUCT REVISION Assigned by UNIVER
<b>5</b> ARM POSITION V = 90°  O = 180°  N = No arm 	<b>10</b> ATEX X = ATEX option See ATEX Catalogue for types and versions

2

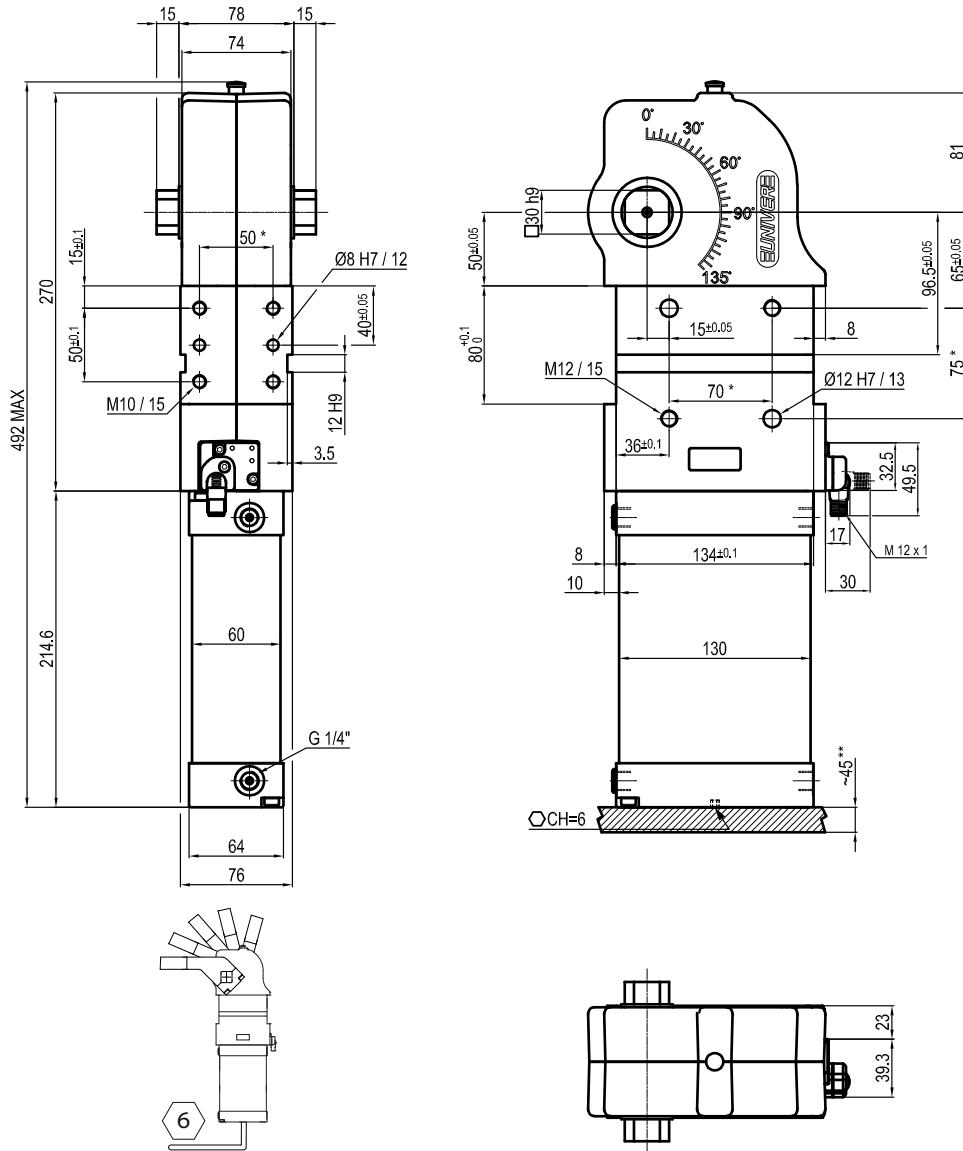

\* TOLERANCE BETWEEN DOWELS ± 0,02, BETWEEN SCREW HOLES ± 0,1  
 \*\* AREA TO ACCESS ANGLE ADJUSTMENT

### Maximum Applicable Load

Pressure: 5 bar - 90° cycle time (Open - Close)

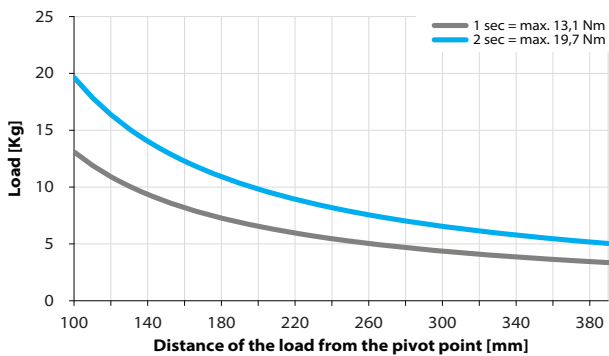

### Air Consumption per Cycle

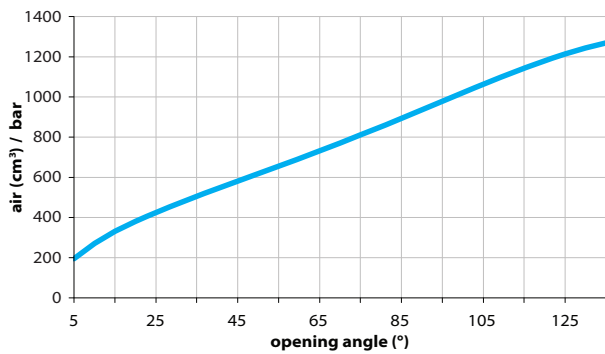



## Clamping Arms

### Arm Offset 20mm

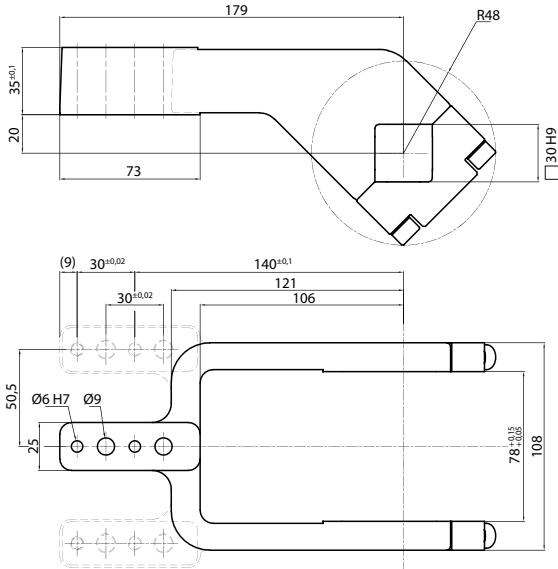

### Arm Offset 45mm

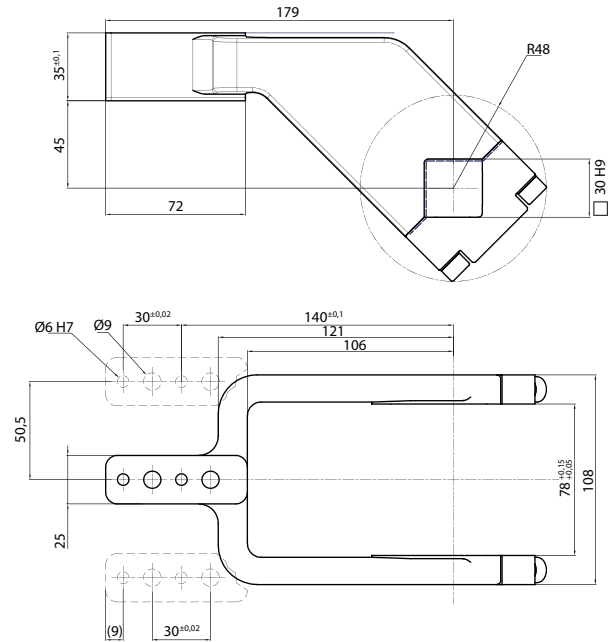

2



Armcode	Offset	Material	Arm style	Weight (Kg)	Opening angle (90°)	Opening angle (180°)
LKP80C	20	ALUMINIUM	CENTRAL	0,6	0÷135°	0÷105°
LKP80D	20	ALUMINIUM	RIGHT	0,6	0÷135°	0÷105°
LKP80S	20	ALUMINIUM	LEFT	0,6	0÷135°	0÷105°
UKP80CS	20	STEEL	CENTRAL	2,3	0÷135°	0÷105°
UKP80DS	20	STEEL	RIGHT	2,3	0÷135°	0÷105°
UKP80SS	20	STEEL	LEFT	2,3	0÷135°	0÷105°
UKP80E	45	ALUMINIUM	CENTRAL	0,6	0÷135°	0÷125°
UKP80F	45	ALUMINIUM	RIGHT	0,6	0÷135°	0÷125°
UKP80L	45	ALUMINIUM	LEFT	0,6	0÷135°	0÷125°
UKP80ES	45	STEEL	CENTRAL	2,2	0÷135°	0÷125°
UKP80FS	45	STEEL	RIGHT	2,2	0÷135°	0÷125°
UKP80LS	45	STEEL	LEFT	2,2	0÷135°	0÷125°

## Sensors



Electronic (optical)

DF-K PNP M12  
DF-J NPN M12  
DF-Y PNP M12 White LED



Pneumatic

DF-UPNW80

## Accessories



Self holding system

UBK46P30