

PNEUMATIC LOCATING PIN UNITS

Pneumatic retractable locating pin unit, typically used in welding applications to locate metal sheets in a definite position.

Available version with hand lever and toggle-joint mechanism

- Metal rod scraper on single shaft only
- Antirotation system
- Electronic sensor with M12 swivel connector or pneumatic sensor



UNICLAMP
next generation

MILLIONS OF CYCLES

3 Millions of operations granted with no maintenance required



QR CODE

Helps identify products quickly and easily



LIGHTWEIGHT

Housing in aluminium alloy
The lightest among market equivalent devices



REDUCED DIMENSIONS



DOUBLE GUIDE

Precision





COMPACT SIZE 32

Pneumatic pin unit with very compact overall dimensions

- Pneumatic with side or rear sensor Ø32 mm



SINGLE AND DOUBLE ROD

Standard range of pin units offering many version combinations with single or double rod and equipped with hand lever for manual operations

- Pneumatic Ø40-50-63 mm
- Pneumatic with hand lever Ø50 mm
- Manual 50 mm
- Wide range of shaft-ends



IRREVERSIBLE

Pin units equipped with toggle-joint mechanism to maintain the position even with lack of air

- Single and double rod Ø40-50 mm
- With hand lever Ø40-50 mm



CNOMO STANDARD

Pin unit construction meeting CNOMO Standard

- Single rod Ø50-63 mm
- With hand lever Ø50 mm

DOUBLE ROD VERSION

180° ORIENTABLE RODS

Possibility to self-orientate the rods 180°
Stock reduction

METAL ROD SCRAPER

Protecting from the entry of dust and
welding debris

OPTICAL SENSOR

High precision system
No adjustment required

CHROMIUM-PLATED STEEL RODS

Preventing deterioration
and corrosion

DOUBLE GUIDE

Radial backlash free
Precision

REDUCED DIMENSIONS

Compact end covers

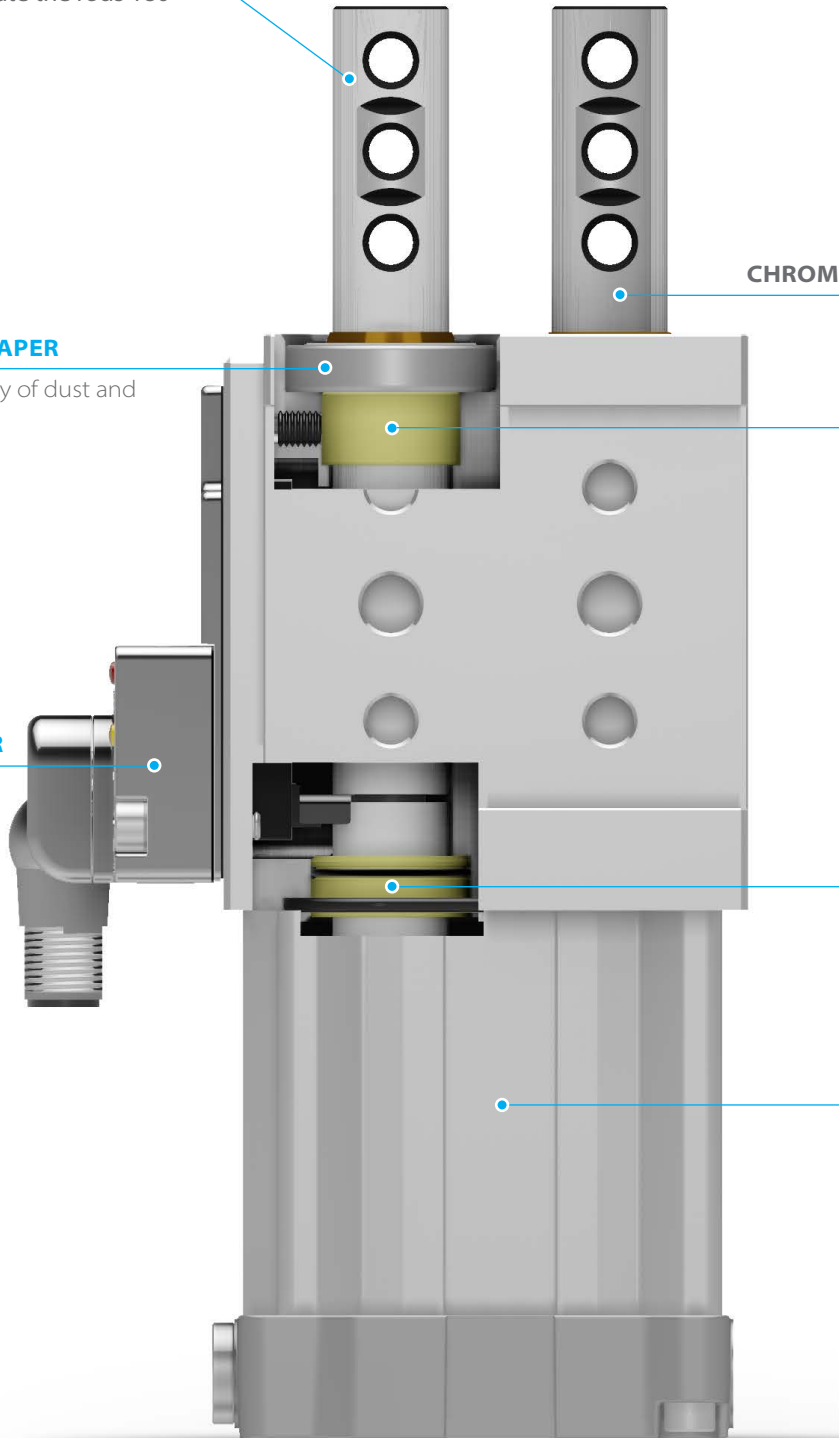

LOCATING PIN UNITS FEATURES

IRREVERSIBLE VERSION

ORIENTABLE ROD

Possibility to self-orientate the rods 180°
Stock reduction

METAL ROD SCRAPER

Protecting from the entry of dust
and welding debris

OPTICAL SENSOR

High precision system
No adjustment required

CHROMIUM-PLATED STEEL RODS

Preventing deterioration and corrosion

DOUBLE GUIDE

Radial backlash free
Precision

COMPACT DIMENSIONS

TOGGLE-JOINT

Irreversible rod extend position
High trust force

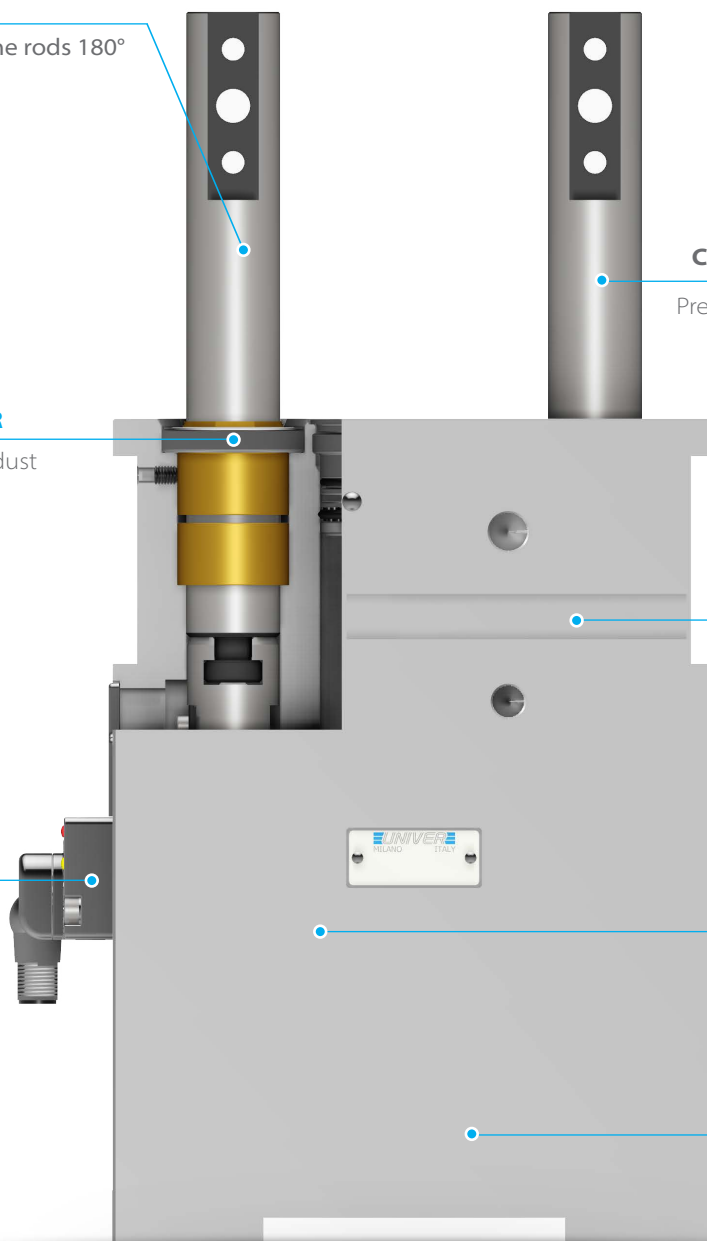



 **METAL ROD SCRAPER**

To prevent dust and welding debris entering the unit body, each piston rod is equipped with a metal rod scraper



 **ANTIROTATION SYSTEM**

Radial cylindrical ball-bearings enable the shaft not to rotate axially and guarantee positioning precision

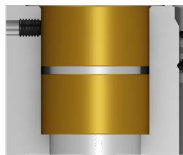

 **DOUBLE GUIDE**

Internal piston rod double guide assures zero radial backlash and positioning precision

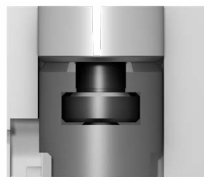

 **ORIENTABLE RODS**

The piston rods on double rod models are 180° orientable by the user to offer installation flexibility and stock reduction



 **IRREVERSIBLE**

Models equipped with the UNIVER original toggle-joint mechanism guarantee irreversibility of the extended piston rod and high thrust force

Irreversible even with lack of air and without external stops



 **OPTICAL SENSOR**

Fully metal body

One single sensor for the whole range of products

IP67 protection

M12 swivel connector (0-90°)

High precision

No set up

Two-parts design: electronic part outside the unit (available as spare part), optical part inside the unit (no touch point)

Insensitive to high magnetic fields, typical of new and modern welding systems like aluminium welding

Industry-recognized, tested and proven sensor

LOCATING PIN UNITS RODS

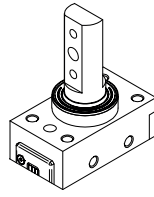

Rod for off-set pins

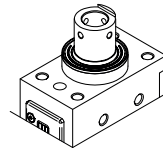

Profiled end

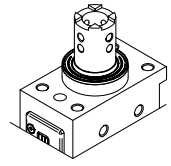

Cross-profiled Ø16

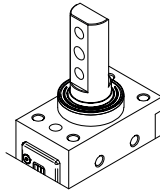

Oversized dowel holes

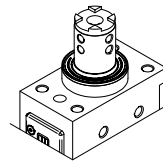

Cross-profiled Ø10

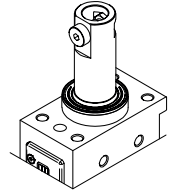

NAAMS COMPATIBLE Ø16

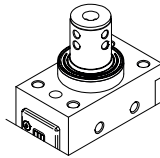

Flat Ø10

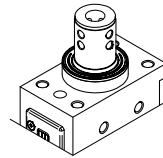

FLAT Ø12

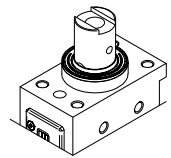

CNOMO Ø12

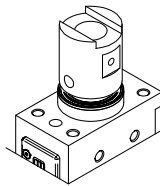

CNOMO Ø20

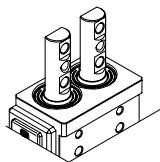

ROD FOR OFFSET PINS
2 SCREWS - 1 DOWEL

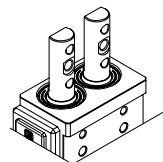

ROD FOR OFFSET PINS
1 SCREW - 2 DOWELS

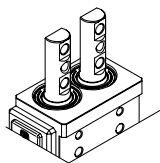

ROD FOR OFFSET PINS
(ROD PLANE MATCHING
BODY MIDDLE AXIS)
2 SCREWS - 1 DOWEL

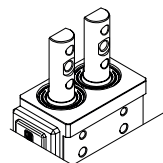

ROD FOR OFFSET PINS
(ROD PLANE MATCHING
BODY MIDDLE AXIS)
1 SCREW - 2 DOWELS

COMPLEMENTARY PRODUCTS



PNEUMATIC SENSOR

- Compact design
- Fully metal body
- Easy to be replaced
- One-piece construction



HAND LEVER

- Ergonomic design
- Welding debris resistant

ULO 50

Pneumatic retractable locating pin unit, double rod, Ø50 mm with hand lever

Pneumatic retractable pin unit with double rod and hand lever, typically used in welding applications to locate metal sheets in a definite position.

- Metal rod scraper
- Double guide to avoid backlash
- Compact dimensions
- Electronic or pneumatic sensor
- Many rod end styles available
- Ergonomic hand lever
- Rod orientation adjustable by the user



3

CHARACTERISTICS

Operating temperature	5° ÷ 45° C
Min./Max. operating pressure	0,4 / 0,6 MPa
Bore Ø	50 mm
Max. Torque (20 Nm)	± 0,1 mm
Max. Deflection (20 Nm)	± 0,03 mm
Weight	5,0 Kg
Pneumatic supply ports	G 1/4 on both sides
Sensor	electronic (optical)
Supply voltage	10 ÷ 30 Vdc
IP code	IP 65

CODIFICATION KEY

UL | O | 50 | 040 | A | K | 0 |

1 2 3 4 5 6 7



OPTICAL SENSOR



LIGHTWEIGHT



COMPACT



METAL SCRAPER



DOUBLE GUIDE

1

SERIES
UL = UNICLAMP locating pin unit

2

VERSION
O = Pneumatic, double orientable rod with hand lever

3

SIZE
050 = Ø50 mm

4

STROKE
015 = 20 mm
025 = 25 mm
040 = 40 mm
050 = 50 mm
060 = 60 mm

5

ROD END STYLE
A = Rod for offset pins (2 screws, 1 dowel)

6

SENSOR
N = No sensor (with protection plate)
K = Electronic sensor PNP, M12 (DF-K)
D = Pneumatic sensor (DF-UPNW)
J = Electronic sensor NPN, optical (DF-J)
Y = Electronic sensor PNP, M12 (DF-Y) white LED

7

PRODUCT REVISION
Assigned by UNIVER

