

Vacuum Pad for Flat or Round Work-piece

Vacuum Pad Standard Series

490

■ Pad shape : 3 types

Small ▷ Small work-piece and semiconductor facility.

General ▷ Best suitable for flat work-piece.

Flat work-piece : Work-piece with enough hardness and thickness

Deep ▷ Suitable for round fruit or ball.

Round fruit : Apple, etc.

■ Wide selection of pad sizes, materials and holder types.

Pad size : 20 sizes. Pad material : 10 types. Holder type : 14 types.

■ Stroke length of a spring holder is selectable.

- Conventional long stroke holder (with cover) is integrated into VPC or VPD.

Stroke : 3, 6, 10, 15 and 20 mm







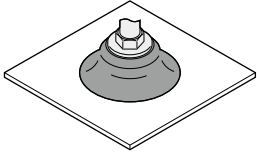
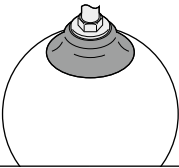

- Conventional long stroke holder (without cover) is renewed as VPOC or VPOD.

Stroke : 20, 30, 40, 50mm

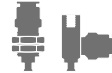
■ Variety of selections in pad holder for "Copper alloy free" and against "low ozone concentration".

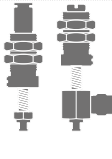
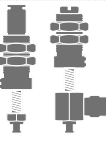
-S3 spec. : No copper based metal parts. HNBR or FKM is adopted for seal rubber.

Selection list

Pad type	Small		General		Deep	
Recommended work-piece	Small work-piece or in semiconductor manufacturing facility 		Flat work-piece with enough hardness and thickness 		Round fruit like an apple, or round ball 	
Pad size	6 sizes ø0.7, ø1, ø1.5, ø2, ø3, ø4mm		18 sizes ø1, ø2, ø3, ø4, ø6, ø8, ø10, ø15, ø20, ø25, ø30, ø40, ø50, ø60, ø80, ø100, ø150, ø200mm		9 sizes ø15, ø20, ø25, ø30, ø40, ø50, ø60, ø80, ø100mm	
Pad material	10 types Nitrile rubber, Silicone rubber, Urethane rubber, Fluoro rubber, Conductive silicone rubber, Conductive butadiene rubber (Low resistance), Conductive NBR (Low resistance), Food safe NBR(※), HNBR, EPDM		10 types Nitrile rubber, Silicone rubber, Urethane rubber, Fluoro rubber, Conductive silicone rubber, Conductive buradiene rubber (Low resistance), Conductive NBR (Low resistance), Food safe NBR(※), HNBR, EPDM		8 types Nitrile rubber, Silicone rubber, Urethane rubber, Fluoro rubber, Conductive NBR (Low resistance), Food safe NBR(※), HNBR, EPDM	
Holder size	Standard	Mini	Standard	Mini	Standard	Mini
Holder type	—	5 types	9 types	5 types	9 types	4 types
Fixed type						
Spring type			 Holder without cover is available. Slim holder is available for Top port holder.		 Holder without cover is available. Slim holder is available for Top port holder.	
Direct mount (Fixed type or Spring type)						

■ Model designation of Pad rubber only (Ex.)

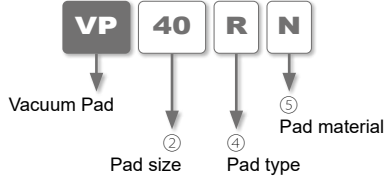

② .Pad size

Code	0.7	1	1.5	2	3	4	6	8	10	15	20	25	30	40	50	60	80	100	150	200
Size (mm)	ø0.7	ø1	ø1.5	ø2	ø3	ø4	ø6	ø8	ø10	ø15	ø20	ø25	ø30	ø40	ø50	ø60	ø80	ø100	ø150	ø200
Pad type	Small	○	○	○	○	○	○													
	General		○	○	○	○	○	○			○	○	○	○	○	○	○	○	○	○
	Deep									○	○	○	○	○	○	○	○	○		

※ 1. Available size for Conductive silicone rubber, Conductive butadiene rubber (Low resistance) and Food safe NBR is limited to ø1~ø50mm.

※ 2. Deep type is not available for Conductive silicone rubber and Conductive butadiene rubber (Low resistance).

④ .Pad type

Code	RM		R		A	
Type	Small		General		Deep	

⑤ .Pad material / Application

Code	N	S	U	F	SE	E	NE	G	HN	EP
Rubber material	Nitrile rubber	Silicone rubber	Urethane rubber	Fluoro rubber	Conductive Silicone rubber	Conductive Butadiene rubber (Low resistance)	Conductive NBR (Low resistance)	NBR Suited for the food sanitation act. Japan	HNBR	EPDM
Pad type	Small	○	○	○	○	○	○	○	○	○
	General	○	○	○	○	○	○	○	○	○
	Deep	○	○	○	○	—	—	○	○	○
Application	Cardboard Plywood Iron plate Food-related Other general work-pieces	Semiconductors Taking out molded parts Thin work-pieces Food-related	Cardboard Plywood Iron plate	Chemical environment High temp. work-pieces	Semiconductors Taking out molded parts Thin work-pieces Food-related	General parts of semiconductors	Semiconductors	Cardboard Plywood Iron plate Food-related Other general work-pieces	Cardboard Plywood Iron plate Food-related Other general work-pieces For use under a low ozone concentration environment	Application that requires light-resistance or ozone-proof. For use in a moisture-containing atmosphere.
Color	Black	Natural (Ivory)	Blue	Gray	Black	Black	Black	Gray	Black	Black

※ 1. The conductive Silicone rubber is a silicone rubber capable of releasing static electricity. (Volume resistance : 10⁹Ω·cm or less)

※ 2. The material of Conductive Butadiene rubber (low resistance) is a butadiene rubber (Volume resistance : 200Ω·cm or less)

※ 3. The material of Conductive NBR (low resistance) is a nitrile rubber (Volume resistance : 200Ω·cm or less)

※ 4. Pad material N, NE, and G are not suitable for use under ozone environment.

■ Suction of Spherical Surface (Deep type)

Minimum diameter of suction capacity

Spherical dia : S (mm)	ø20	ø30	ø40	ø50	ø80	ø100	ø120	ø160	ø200
Pad size : d (mm)	ø15	ø20	ø25	ø30	ø40	ø50	ø60	ø80	ø100

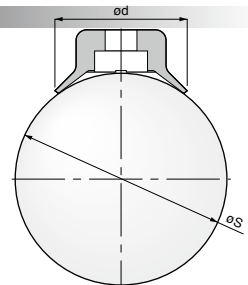

Vacuum Pad dimension (Small type)

VP0.7RM[5] Weight : 0.04g[0.06g]

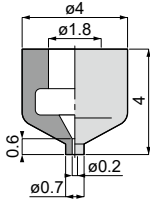

VP1RM[5] Weight : 0.04g[0.07g]

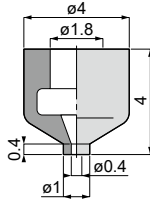

VP1.5RM[5] Weight : 0.04g[0.07g]

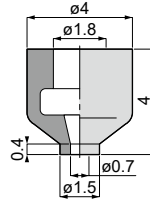

VP2RM[5] Weight : 0.04g[0.06g]

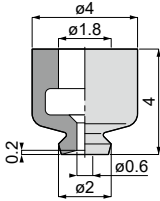

VP3RM[5] Weight : 0.04g[0.06g]

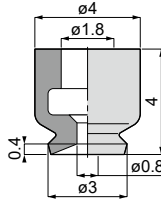

VP4RM[5] Weight : 0.04g[0.07g]

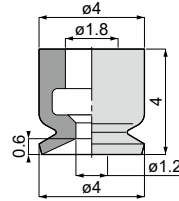

※ Weight in [] is the weight of Fluoro rubber.

Drawing of Vacuum Pad and Holder Joint (Small type)

Unit : mm

VP 0.7~1.5RM[5]

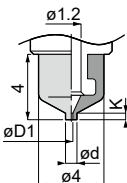

VP 2~4RM[5]

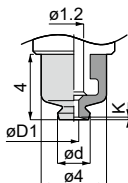

	Model code	Pad O.D. ød	Pad I.D. øDi	K	Connection config. code
Pad rubber only	VP0.7RM[5]	0.7	0.2	0.6	-T4
	VP1RM[5]	1	0.4	0.4	
	VP1.5RM[5]	1.5	0.7	0.4	
	VP2RM[5]	2	0.6	0.2	
	VP3RM[5]	3	0.8	0.4	
	VP4RM[5]	4	1.2	0.6	

※ [5] in Model code : Replaced with Pad rubber material code. refer to page 492 for details.

Dimensions of Pad Inersion Part

VP0.7~4RM[5] Connection configuration code : -T4

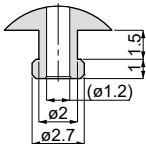

■ Vacuum Pad dimension (Standard type)

VP1R^[5]

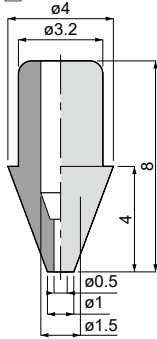

Weight : 0.06g[0.1g]

VP2R^[5]

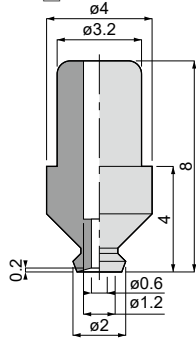

Weight : 0.08g[0.13g]

VP3R^[5]

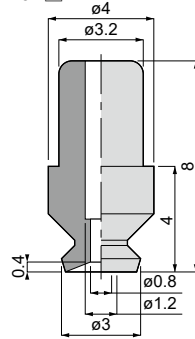

Weight : 0.08g[0.13g]

VP4R^[5]

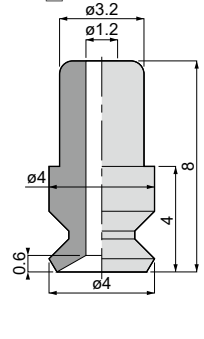

Weight : 0.09g[0.14g]

VP6R^[5]

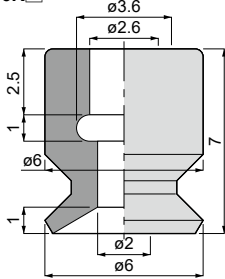

Weight : 0.17g[0.28g]

VP8R^[5]

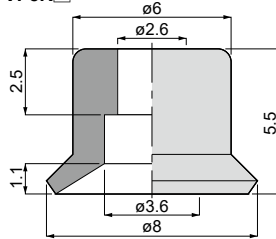

Weight : 0.15g[0.25g]

VP10R^[5]

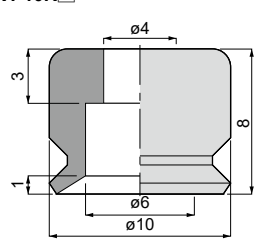

Weight : 0.51g[0.82g]

VP15R^[5]

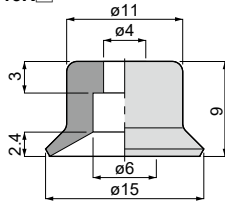

Weight : 0.91g[1.5g]

VP20R^[5]

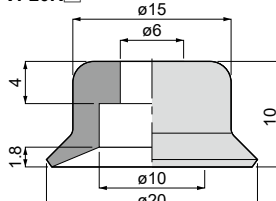

Weight : 1.8g[2.8g]

VP25R^[5]

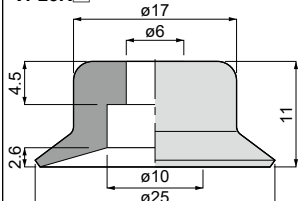

Weight : 2.7g[4.4g]

VP30R^[5]

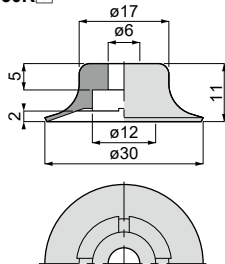

Weight : 2.9g[4.6g]

VP40R^[5]

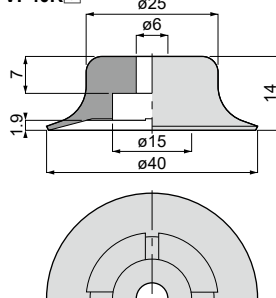

Weight : 8.2g[13.2g]

VP50R^[5]

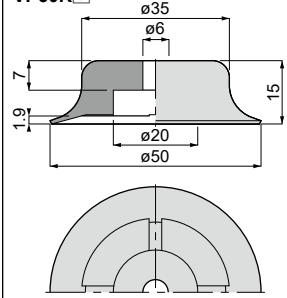



Weight : 17g[27g]

※ Weight in [] is the weight of Fluoro rubber.

※ Pad model code : VP1RNE (Pad dia. : ϕ 1mm, Pad material : Conductive NBR) is not compliant to Revised RoHS directive.

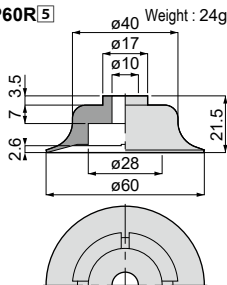
VP60R  Weight : 24g[38g]



VP80R  Weight : 36g[58g]

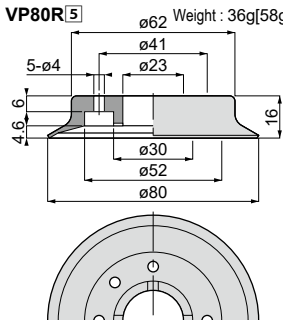

VP100R  Weight : 65g[104g]

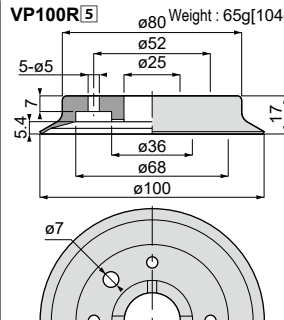

VP150R  Weight : 393g[630g]

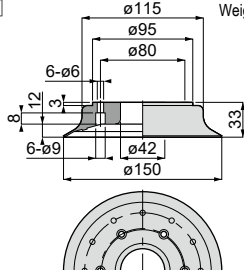

VP200R  Weight : 919g[1476g]

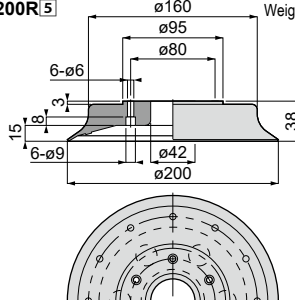

VP80R -M10(with screws) Weight : 128.5g[150.5g]

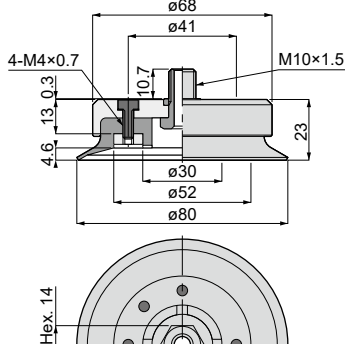

VP100R -M10(with screws) Weight : 218.5g[257.5g]

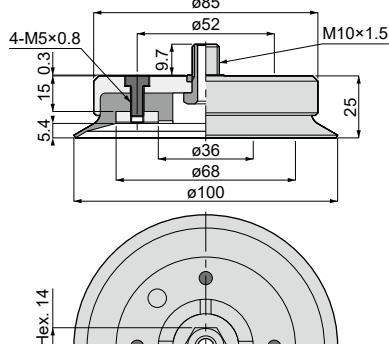

VP150R -M20(with screws) Weight : 762g[999g]

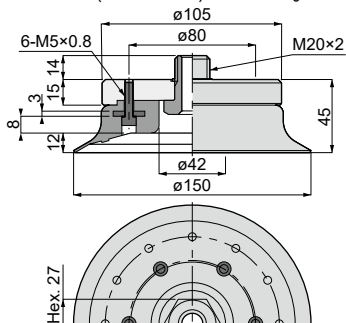

VP200R -M20(with screws) Weight : 1,288g[1,845g]

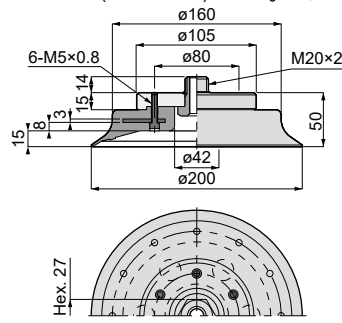

■ Vacuum Pad dimensions (Deep type)

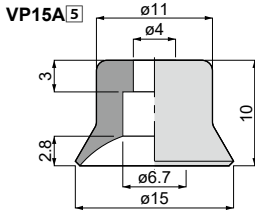

Weight : 1.0g[1.6g]

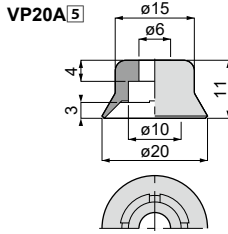

Weight : 1.7g[2.7g]

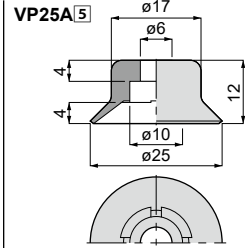

Weight : 2.5g[3.9g]

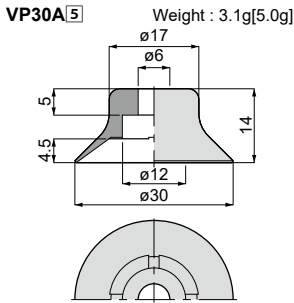

Weight : 3.1g[5.0g]

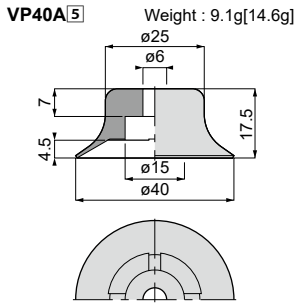

Weight : 9.1g[14.6g]

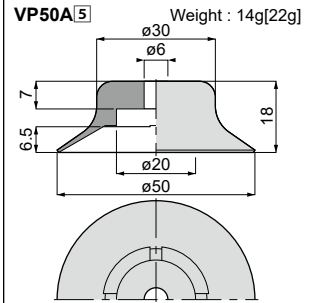

Weight : 14g[22g]

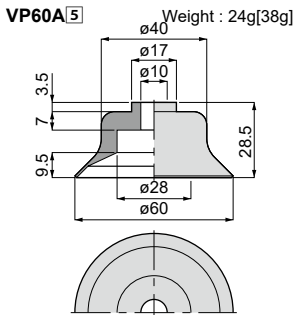

Weight : 24g[38g]

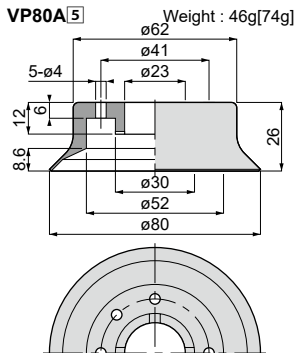

Weight : 46g[74g]

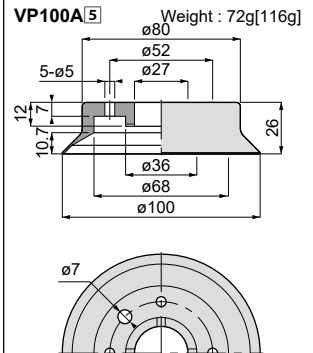

Weight : 72g[116g]

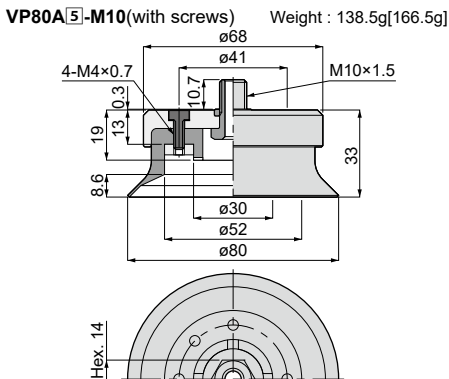

Weight : 138.5g[166.5g]

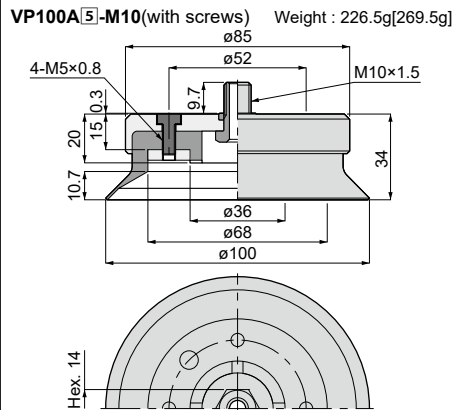

Weight : 226.5g[269.5g]

※ Weight in [] is the weight of Fluoro rubber.

■ Drawing of Vacuum Pad and Holder Joint (General · Deep type)

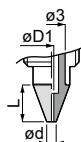
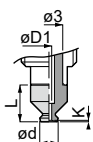
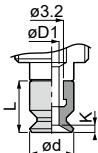
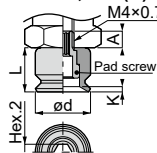
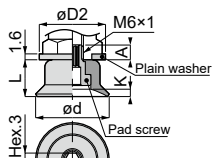
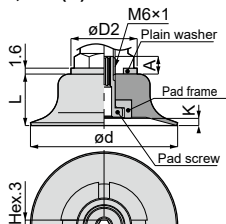
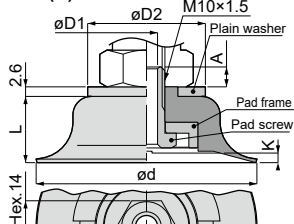
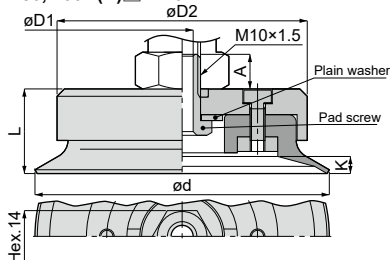
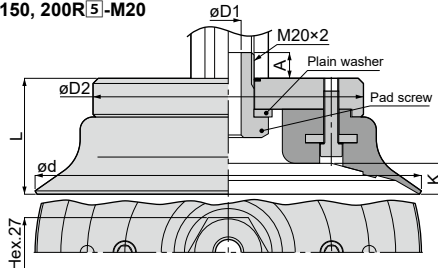
VP1R

VP2~4R

VP6, 8R

VP10R -M4, **15R(A)** -M4

VP20~30R(A) -M6

VP40, 50R(A) -M6

VP60R(A) -M10

VP80, 100R(A) -M10

VP150, 200R -M20

Unit : mm

	. cogModel code	Pad O.D. ød	L	Inner lip height K	A	øD1	øD2	Connection config. code
Pad rubber only	VP1R	1	4	-	-	0.5	-	-H3
	VP2R	2	4	0.2	-	0.6	-	
	VP3R	3	4	0.4	-	0.8	-	
	VP4R	4	4	0.6	-	1.2	-	
Pad & screw set	VP6R	6	7	1	-	2	-	-T8
	VP8R	8	5.5	1.1	-	2	-	
	VP10R	10	8	1	3	-	-	-M4
	VP15R(A)	15	9(10)	2.4(2.8)	3	-	-	
	VP20R(A)	20	10(11)	1.8(3)	4	-	15.5	-M6
	VP25R(A)	25	11(12)	2.6(4)	3.5	-	15.5	
	VP30R(A)	30	11(14)	2(4.5)	5	-	15.5	
	VP40R(A)	40	14(17.5)	1.9(4.5)	5.5	-	22	
	VP50R(A)	50	15(18)	1.9(6.5)	5.5	-	22	
	VP60R(A)	60	18(25)	2.6(9.5)	5.4	6	32	
	VP80R(A)	80	23(33)	4.6(8.6)	9.4	6	68	-M10
	VP100R(A)	100	25(34)	5.4(10.7)	8.4	6	85	
	VP150R	150	45	12	11	10	105	-M20
	VP200R	200	50	15	11	10	105	

※ 1. [] in Model code : Replace with Pad rubber material code. Refer to page 492 for details.

※ 2. Value in () is the dimension of a deep type pad.

■ Model designation of Pad & screw set (Ex.)

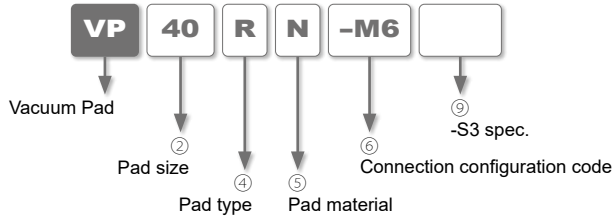

For ②, ④ and ⑤, refer to "Model designation of Pad rubber only (Ex.)" on page 492.

⑥ .Connection configuration code

Code	-M4	-M6	-M10	-M20
Thread size	M4×0.7	M6×1	M10×1.5	M20×2
Applicable pad size (mm)	ø10, ø15	ø20, ø25, ø30, ø40, ø50	ø60, ø80, ø100	ø150, ø200

⑨ .-S3 spec.

Code	No code	-S3
Spec.	Standard	Metal parts : Copper alloy free material Seal parts : FKM or HNBR

■ Dimension of Pad insertion part

■ Dimension of Pad insertion part

VP1-4R^⑤ Connection configuration code : **-H3**

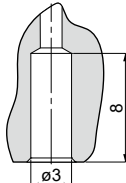

VP6, 8R^⑤ Connection configuration code : **-T8**

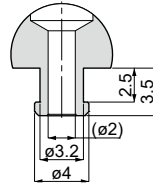

■ Pad screw dimensions

VP10R^⑤, 15R(A)^⑤

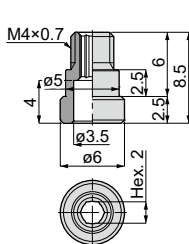

Connection configuration code : **-M4**

VP20-50R(A)^⑤

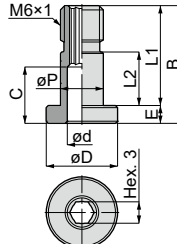

Connection configuration code : **-M6**

VP60-100R(A)^⑤

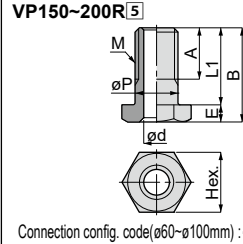

Connection config. code(ø60-ø100mm) : **-M10**

Connection config. code(ø150, ø200mm) : **-M20**

Unit : mm

Pad screw Model code	M	øD	ød	øP	E	A	C	B	L1	L2	Hex.	Weight (g)	Applicable pad model code
VPM46-6	-	-	-	-	-	-	-	-	-	-	-	0.8	VP10R ^⑤ , 15R(A) ^⑤
VPM610-8	-	10	4.5	7	2.5	-	5	10.5	8	3.5	-	2.5	VP20, 25R(A) ^⑤
VPM612-10	-	12	4.5	7	3	-	6	13	10	4	-	3.9	VP30R(A) ^⑤
VPM610-15	-	10	4.1	6	2.5	-	7.9	16	13.5	7.5	-	3.1	VP40, 50R(A) ^⑤
VPM1018	M10×1.5	-	6	10	4	12	-	22	18	-	14	9.5	VP60~100R(A) ^⑤
VPM2028	M20×2	-	10	20	8	15	-	34	26	-	27	75	VP150~200R ^⑤

Material : Electroless nickel-plated brass (In case of metal parts : Standard)

Special stainless steel (austenitic or ferrite) (In case of metal parts : Copper alloy free material)



Vacuum Pad Series

Vacuum Pad Standard Series

Plain washer dimensions

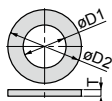

Unit : mm

Plain washer model code	O.D. øD2	I.D. øD1	T	Weight (g)	Applicable pad model code
HW8.4×15.5×1.6	15.5	8.4	1.6	2	VP20-30R(A) [5]
HW8.5×22×1.6	22	8.5	1.6	3.5	VP40, 50R(A) [5]
HW10.5×22×1.6	22	10.5	1.6	4	VP80, 100R(A) [5]
HW21×34×3	34	21	3	12	VP150, 200R [5]
HW17×32×2.6	32	17	2.6	12	VP60R(A) [5]

Material : Electroless nickel-plated steel iron

Pad support dimensions

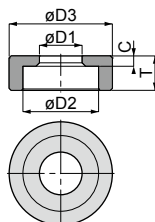

Unit : mm

Pad support model code	O.D. øD1	I.D. øD2	O.D. øD3	T	C	Weight (g)	Applicable pad model code
VPW40	6.2	11	15	5	1.5	1.4	VP40R(A) [5]
VPW50	6.2	12	20	4.3	1.5	2.8	VP50R(A) [5]
VPW60	10.2	23	28	7	3	6.8	VP60R(A) [5]

Material : Aluminium

Table of Connection configuration code., etc for connection of pad and holder

	Pad dia. (mm)	Model code of pad rubber ([5] : Replaced with pad material code)	Connection type	Connection configuration code	Model code of Pad & screw set ([5] : Replaced with pad material code)
Small	ø0.7	VP0.7RM [5]	Mount type (Direct connection)	-T4	-
	ø1	VP1RM [5]			
	ø1.5	VP1.5RM [5]			
	ø2	VP2RM [5]			
	ø3	VP3RM [5]			
General	ø4	VP4RM [5]	Insert type (Direct connection)	-H3	-
	ø1	VP1R [5]			
	ø2	VP2R [5]			
	ø3	VP3R [5]			
	ø4	VP4R [5]			
General / Deep	ø6	VP6R [5]	Mount type (Direct connection)	-T8	-
	ø8	VP8R [5]			
	ø10	VP10R [5]	Screw type (Connection with screw)	-M4	VP10R [5]-M4
	ø15	VP15R [5] / VP15A [5]			
	ø20	VP20R [5] / VP20A [5]			
	ø25	VP25R [5] / VP25A [5]			
	ø30	VP30R [5] / VP30A [5]			
	ø40	VP40R [5] / VP40A [5]			
	ø50	VP50R [5] / VP50A [5]			
	ø60	VP60R [5] / VP60A [5]			
General	ø80	VP80R [5] / VP80A [5]	-	-M6	VP10R [5]-M4 VP15R [5]-M4 / VP15A [5]-M4 VP20R [5]-M6 / VP20A [5]-M6 VP25R [5]-M6 / VP25A [5]-M6 VP30R [5]-M6 / VP30A [5]-M6 VP40R [5]-M6 / VP40A [5]-M6 VP50R [5]-M6 / VP50A [5]-M6 VP60R [5]-M10 / VP60A [5]-M10
	ø100	VP100R [5] / VP100A [5]			
	ø150	VP150R [5]			
	ø200	VP200R [5]			
				-M10	VP80R [5]-M10 / VP80A [5]-M10
				-M20	VP100R [5]-M10 / VP100A [5]-M10 VP150R [5]-M20 VP200R [5]-M20

■ Pad frame dimensions

VPH 80R
VPH 100R

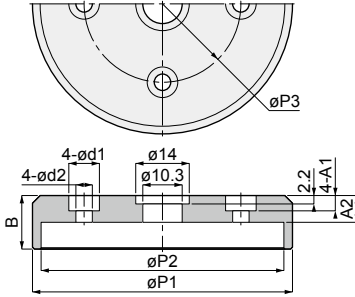

VPH 150R

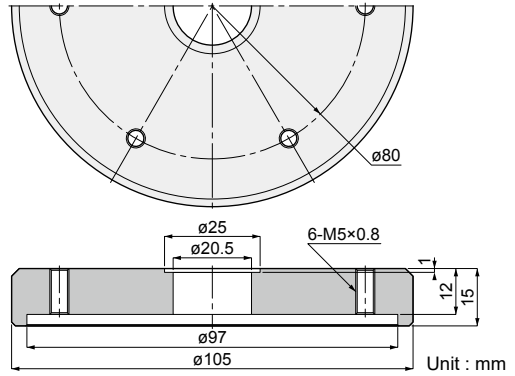

Pad frame model code	B	A1	A2	øP1	øP2	øP3	ød1	ød2	Weight (g)	Applicable pad model code
VPH80R	14	4.4	7	68	63.5	41	8.4	4.3		VP80R(A) [5]
VPH100R	15	6.5	8	85	81.5	52	9.5	5.3		VP100R(A) [5]
VPH150R	-	-	-	-	-	-	-	-		VP150R [5], VP200R [5]

Material : Aluminium

Table of complement parts model code

	Pad screw	Plain washer	Pad support	Pad frame	Hexagon socket head bolt	Rubber packing	Gasket
-	-	-	-	-	-	-	-
-	-	-	-	-	-	-	-
-	-	-	-	-	-	-	-
VPM46-6	-	-	-	-	-	-	-
VPM610-8	-	HW8.4×15.5×1.6	-	-	-	-	-
VPM612-10	-	-	-	-	-	-	-
VPM610-15	-	HW8.5×22×1.6	VPW40	-	-	-	-
			VPW50	-	-	-	-
		HW17×32×1.6	VPW60	-	-	-	-
VPM1018		HW10.5×22×1.6	VPW80	VPH80R	VPH80CS-SET (4pcs of bolts)	VPH80P-SET (4pcs of packings)	SG10
			VPW100	VPH100R	VPH100CS-SET (4pcs of bolts)	VPH100P-SET (4pcs of packings)	
VPM2028		HW21×34×3	VPW150	VPH150R	VPH150CS-SET (6pcs of bolts)	VPH150P-SET (6pcs of packings)	22×1.5
			VPW200				

Model designation of Holder + Pad (Ex.)

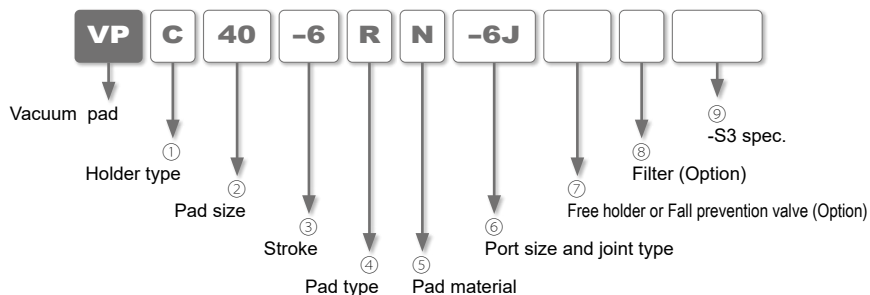

①. Holder type

Code	Mini	MA	Code	Mini	MB	Code	Mini	MC
	Slim	-		Slim	-		Slim	SC
	Standard	A		Standard	B		Standard	C
	No cover	-		No cover	-		No cover	OC
Type	Fixed type / Top port		Type	Fixed type / Side port		Type	Spring type / Top port	
Code	Mini	MD	Code	Mini	ME	Code	Mini	-
	Slim	-		Slim	-		Slim	-
	Standard	D		Standard	E		Standard	F
	No cover	OD		No cover	-		No cover	-
Type	Spring type / Side port		Type	Fixed type / Direct mount		Type	Spring type / Direct mount	

②. Pad size

Code	0.7	1	1.5	2	3	4	6	8	10	15	20	25	30	40	50	60	80	100	150	200	
Size (mm)	ø0.7	ø1	ø1.5	ø2	ø3	ø4	ø6	ø8	ø10	ø15	ø20	ø25	ø30	ø40	ø50	ø60	ø80	ø100	ø150	ø200	
Pad type / Connection config. code	Small	○	○	○	○	○															
	-T4																				
	General		○		○	○	○	○	○	○	○	○	○	○	○	○	○	○	○	○	○
				-H3				-T8			-M4			-M6			-M10			-M20	
Deep																					
										-M4			-M6			-M10					



※ Available size for Conductive silicone rubber, Conductive butadiene rubber (Low resistance) and Food safe NBR is limited to ø1~ø50mm.

③. Stroke (Code entry for Spring type pad holder only, except VPF)

Code	-2	-3	-4	-6	-10	-15	-20	-30	-40	-50
Stroke (mm)	2	3	4	6	10	15	20	30	40	50
Pad holder code	VPMC	○ (-T4)		○ (-T8)						
	VPSC		○ (-H3)							
	VPC		○ (-H3)		○ (-M4, -M6)	○ (H3, T8, M4, M6)	○ (H3, T8, M4, M6)			
	VPOC							○ (-M6)	○ (-M6)	○ (-M6)
	VPMD	○ (-T4)		○ (-T8)						
	VPD		○ (-H3)		○ (-M4, -M6)	○ (H3, T8, M4, M6)	○ (H3, T8, M4, M6)	○ (H3, T8, M4, M6)		
	VPOD							○ (-M6)	○ (-M6)	○ (-M6)

※ Code in () : Connection configuration code.

④ .Pad type

Code	RM		R		A	
Type	Small		General		Deep	

⑤ .Pad material / Application

Code	N	S	U	F	SE	E	NE	G	HN	EP
Material	Nitrile rubber	Silicone rubber	Urethane rubber	Fluoro rubber	Conductive Silicone rubber	Conductive Butadiene rubber (Low resistance)	Conductive NBR (Low resistance)	Food safe NBR	HNBR	EPDM
Type	Small	○	○	○	○	○	○	○	○	○
	General	○	○	○	○	○	○	○	○	○
	Deep	○	○	○	○	—	—	○	○	○
Application	Cardboard Plywood Iron plate Food-related Other general work-pieces	Semiconductors Taking out molded parts Thin work-pieces Food-related	Cardboard Plywood Iron plate	Chemical environment High temp. work-pieces	Semiconductors Taking out molded parts Thin work-pieces Food-related	General parts of Semiconductors	Semiconductors	Cardboard Plywood Iron plate Food-related Other general work-pieces	Cardboard Plywood Iron plate Food-related Other general work-pieces For use under a low ozone concentration environment	Application that requires light-resistance or ozone-proof. For use in a moisture-containing atmosphere
Color	Black	Transparent	Blue	Grey	Black	Black	Black	Grey	Black	Black

※ 1. Conductive Silicone rubber is a silicone rubber capable of releasing static electricity. (Volume resistance : Max. 10⁹Ω·cm)

※ 2. The material of Conductive Butadiene rubber (low resistance) is a butadiene rubber. (Volume resistance : Max. 200Ω·cm)

※ 3. The material of Conductive NBR (low resistance) is a nitrile rubber. (Volume resistance : Max. 200Ω·cm)

※ 4. Pad material N, NE, and G are not suitable for use under ozone environment.

※ 5. Holder type of VPMC, VPMD (Standard and "-S3" spec.) and VPC, VPD ("-S3" spec.) are not compliant with Japan Food Sanitation Act.

⑥ .Port size and joint type

Joint type	Push-in fitting (mm)								Barb fitting (mm)			Female thread				Male thread			
Code	-180J	-2J	-3J	-4J	-6J	-8J	-10J	-12J	-3B	-4B	-6B	-M3	-M5	-M6	-G1	-G2	-M3	-M5	
Size	ø1.8	ø2	ø3	ø4	ø6	ø8	ø10	ø12	ø3×ø2	ø4×ø2.5	ø6×ø4	M3×0.5	M5×0.8	M6×1	G1/8	G1/4	M3×0.5	M5×0.8	
Pad connection config. code	-T4	○	○	○					○	○	○	○						○	
	-H3	○	○	○	○	○			○	○	○	○						○	
	-T8	○	○	○	○	○			○	○	○	○						○	
	-M4	○	○	○	○	○			○	○	○		○	○					
	-M6	○	○	○	○	○			○	○	○		○	○					
	-M10				○	○	○									○			
	-M20						○	○	○								○		

※ .Joint size differs depending on the holder type. Check the joint size by Pad connection config. code in ③, or the holder dimensions lists in following pages.

⑦ .Free holder or Fall prevention valve (Option)

Code	-FH	-FHH	-ECV
Option	Free holder articulation angle : 30°	Free holder articulation angle : 15°	Fall prevention valve
Pad dia. (mm)	ø10~ø100		ø10~ø100 and VPME, VPE : ø0.7~ø8

⑧ .Filter (Option)

Code	-F15	-F30
Pad dia. (mm)	ø10~ø50	

※ .F15 is recommended for pad size ø10~ø25mm.

⑨ .-S3 spec.

Code	No code	-S3
Spec.	Standard	Metal parts material : Copper alloy free material Sealing parts material : FKM or HNBR

※ 1. Free holder, Fall prevention valve and Filter are not available when "-S3" is selected.

※ 2. "-S3" spec. is not available for push-in fitting size : ø1.8, ø2, ø3mm, and holder with stroke longer than 10mm (except pad size ø60mm or larger).

Vacuum pad + Fixed type holder Dimensions

VPMA Fixed type / Top port / Push-in fitting / Mini holder

VPMA0.7RM [5] [6]

VPMA1RM [5] [6]

VPMA1.5RM [5] [6]

VPMA2RM [5] [6]

VPMA3RM [5] [6]

VPMA4RM [5] [6]

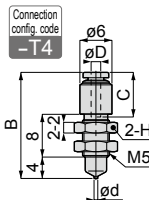

Connection config. code
-T4

VPMA6R [5] [6]

VPMA8R [5] [6]

Connection config. code
-T8

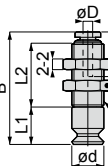

VPMA10R [5] [6] [9]

VPMA15R(A) [5] [6] [9]

Connection config. code
-M4

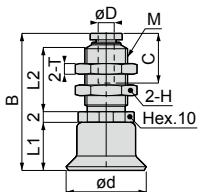

VPMA20R(A) [5]-4J [9]

VPMA25R(A) [5]-4J [9]

VPMA30R(A) [5]-4J [9]

VPMA40R(A) [5]-4J [9]

VPMA50R(A) [5]-4J [9]

Connection config. code
-M6

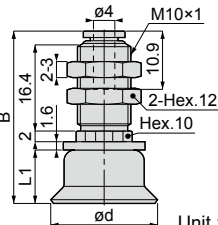

Unit : mm

Model code	Tube O.D. øD	Pad O.D. ød	Thread M	B	L1	L2	Tube end C	Hex. H	T	
VPMA0.7RM [5]-180J	1.8	0.7	-	19.9	-	-	8.4	-	-	
VPMA0.7RM [5]-2J	2			20.6			9.4			
VPMA0.7RM [5]-3J	3			20.6			9.4			
VPMA1RM [5]-180J	1.8	1	-	19.9	-	-	8.4	-	-	
VPMA1RM [5]-2J	2			20.6			9.4			
VPMA1RM [5]-3J	3			20.6			9.4			
VPMA1.5RM [5]-180J	1.8	1.5	-	19.9	-	-	8.4	-	-	
VPMA1.5RM [5]-2J	2			20.6			9.4			
VPMA1.5RM [5]-3J	3			20.6			9.4			
VPMA2RM [5]-180J	1.8	2	-	19.9	-	-	8.4	-	-	
VPMA2RM [5]-2J	2			20.6			9.4			
VPMA2RM [5]-3J	3			20.6			9.4			
VPMA3RM [5]-180J	1.8	3	-	19.9	-	-	8.4	-	-	
VPMA3RM [5]-2J	2			20.6			9.4			
VPMA3RM [5]-3J	3			20.6			9.4			
VPMA4RM [5]-180J	1.8	4	-	19.9	-	-	8.4	-	-	
VPMA4RM [5]-2J	2			20.6			9.4			
VPMA4RM [5]-3J	3			20.6			9.4			
VPMA6R [5]-180J	1.8	6	M6×0.75	21.1	7	12	8.4	8	-	
VPMA6R [5]-2J	2		M8×0.75	21.8			9.4	10		
VPMA6R [5]-3J	3		M8×0.75	21.8			12.5	9.4		10
VPMA8R [5]-180J	1.8	8	M6×0.75	19.6	5.5	12	8.4	8	-	
VPMA8R [5]-2J	2		M8×0.75	20.3			9.4	10		
VPMA8R [5]-3J	3		M8×0.75	20.3			12.5	9.4		10
VPMA10R [5]-3J	3	10	M8×0.75	24.8	8	12.5	9.4	10	2	
VPMA10R [5]-4J [9]	4		M10×1	28.7			16.4	10.9	12	3
VPMA15R(A) [5]-3J	3		M8×0.75	25.8(26.8)			9(10)	12.5	9.4	10
VPMA15R(A) [5]-4J [9]	4	M10×1	29.7(30.7)	16.4	10.9	12			3	
VPMA20R(A) [5]-4J [9]	-	20	-	32.3(33.3)	10(11)	-	-	-	-	
VPMA25R(A) [5]-4J [9]	-	25	-	33.3(34.3)	11(12)	-	-	-	-	
VPMA30R(A) [5]-4J [9]	-	30	-	33.3(36.3)	11(14)	-	-	-	-	
VPMA40R(A) [5]-4J [9]	-	40	-	36.3(39.8)	14(17.5)	-	-	-	-	
VPMA50R(A) [5]-4J [9]	-	50	-	37.3(40.3)	15(18)	-	-	-	-	

※ . Value in () is the dimension of a deep type pad.

※ [5] : Replaced with Pad rubber material code. Refer to page 492 for details.

※ [9] : Replaced with "-S3" for -S3 spec. (Copper alloy free material for metal parts and FKM or HNBR for sealing parts). -S3 spec. is available for model codes with [9] in the table above.

VPMA Fixed type / Top port / Barb fitting / Mini holder

VPMA0.7RM [5][6][9]
VPMA1RM [5][6][9]
VPMA1.5RM [5][6][9]
VPMA2RM [5][6][9]
VPMA3RM [5][6][9]
VPMA4RM [5][6][9]



Connection
config. code
-T4

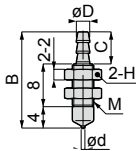

VPMA6R [5][6][9]
VPMA8R [5][6][9]

Connection
config. code
-T8

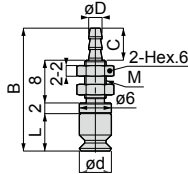

VPMA10R [5][6][9]
VPMA15R(A) [5][6][9]

Connection
config. code
-M4

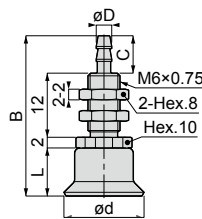

VPMA20R(A) [5][6][9]
VPMA25R(A) [5][6][9]
VPMA30R(A) [5][6][9]
VPMA40R(A) [5][6][9]
VPMA50R(A) [5][6][9]

Connection
config. code
-M6

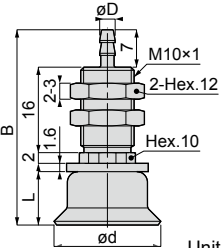

Unit : mm

Model code	Tube I.D. øD	Pad O.D. ød	Thread M	B	L	C	Hex. H
VPMA0.7RM [5]-3B [9]	2	0.7	M4×0.5	18	-	6	6
VPMA0.7RM [5]-4B [9]	2.5		M5×0.5	19		7	7
VPMA1RM [5]-3B [9]	2	1	M4×0.5	18	-	6	6
VPMA1RM [5]-4B [9]	2.5		M5×0.5	19		7	7
VPMA1.5RM [5]-3B [9]	2	1.5	M4×0.5	18	-	6	6
VPMA1.5RM [5]-4B [9]	2.5		M5×0.5	19		7	7
VPMA2RM [5]-3B [9]	2	2	M4×0.5	18	-	6	6
VPMA2RM [5]-4B [9]	2.5		M5×0.5	19		7	7
VPMA3RM [5]-3B [9]	2	3	M4×0.5	18	-	6	6
VPMA3RM [5]-4B [9]	2.5		M5×0.5	19		7	7
VPMA4RM [5]-3B [9]	2	4	M4×0.5	18	-	6	6
VPMA4RM [5]-4B [9]	2.5		M5×0.5	19		7	7
VPMA6R [5]-3B [9]	2	6	M4×0.5	23	7	6	-
VPMA6R [5]-4B [9]	2.5		M5×0.5	24		7	-
VPMA8R [5]-3B [9]	2	8	M4×0.5	21.5	5.5	6	-
VPMA8R [5]-4B [9]	2.5		M5×0.5	22.5		7	-
VPMA10R [5]-3B [9]	2	10	-	28	8	6	-
VPMA10R [5]-4B [9]	2.5		-	29		7	-
VPMA15R(A) [5]-3B [9]	2	15	-	29(30)	9(10)	6	-
VPMA15R(A) [5]-4B [9]	2.5		-	30(31)		7	-
VPMA20R(A) [5]-4B [9]	2.5	20	-	36.6(37.6)	10(11)	-	-
VPMA20R(A) [5]-6B [9]	4		-	-		-	-
VPMA25R(A) [5]-4B [9]	2.5	25	-	37.6(38.6)	11(12)	-	-
VPMA25R(A) [5]-6B [9]	4		-	-		-	-
VPMA30R(A) [5]-4B [9]	2.5	30	-	37.6(40.6)	11(14)	-	-
VPMA30R(A) [5]-6B [9]	4		-	-		-	-
VPMA40R(A) [5]-4B [9]	2.5	40	-	40.6(44.1)	14(17.5)	-	-
VPMA40R(A) [5]-6B [9]	4		-	-		-	-
VPMA50R(A) [5]-4B [9]	2.5	50	-	41.6(44.6)	15(18)	-	-
VPMA50R(A) [5]-6B [9]	4		-	-		-	-

※ .Pad material N, NE, and G are not suitable for use under ozone environment.

※ . [9] : Replaced with "-S3" for -S3 spec. (Copper alloy free material for metal parts and FKM or HNBR for sealing parts).

※ . Tightening torque of a pad holder fixing bulkhead nut is as below.

▪ Pad dia. : ø0.7~ø8mm and Thread size : M4×0.5 ▶ 1~1.2N·m. Thread size: M5×0.5 ▶ 1.5~2N·m.

▪ Pad dia. : ø10, ø15mm ▶ 2~3N·m. ▪ Pad dia. : ø20~ø50mm ▶ 5~7N·m

※ . See Pisco website for weight information.



VPA Fixed type / Top port / Push-in fitting / Standard holder

VPA1R[5][4][9]

VPA2R[5][4][9]

VPA3R[5][4][9]

VPA4R[5][4][9]

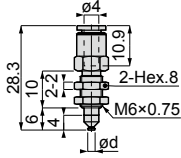

Connection
config. code
-H3

VPA6R[5][6][9]

VPA8R[5][6][9]

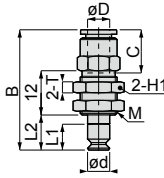

Connection
config. code
-T8

VPA10R[5]-6J[9]

VPA15R(A)[5]-6J[9]

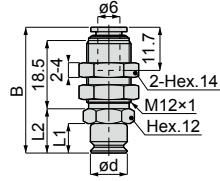

Connection
config. code
-M4

VPA20R(A)[5][6][9]

VPA25R(A)[5][6][9]

VPA30R(A)[5][6][9]

VPA40R(A)[5][6][9]

VPA50R(A)[5][6][9]

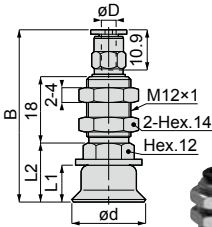

VPA20R(A)[5]-6J[9]

VPA25R(A)[5]-6J[9]

VPA30R(A)[5]-6J[9]

VPA40R(A)[5]-6J[9]

VPA50R(A)[5]-6J[9]

Connection
config. code
-M6

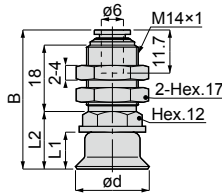

VPA60R(A)[5][6][9]

VPA80R(A)[5][6][9]

VPA100R(A)[5][6][9]

VPA150R[5][6][9]

VPA200R[5][6][9]

Connection
config. code
-M10

Connection
config. code
-M20

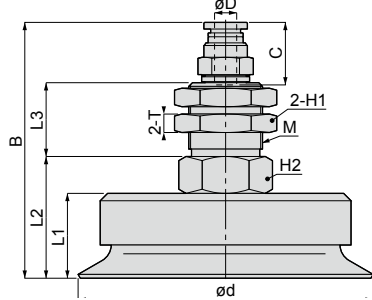

RoHS Compliant ~~Copper alloy free available~~ CAD (2D&3D)

Unit : mm

Model code	Tube O.D. øD	Pad O.D. ød	Thread M	B	L1	L2	L3	Tube end C	Hex. H1	Hex. H2	T			
VPA1R[5]-4J[9]	-	1	-	-	-	-	-	-	-	-	-			
VPA2R[5]-4J[9]	-	2	-	-	-	-	-	-	-	-	-			
VPA3R[5]-4J[9]	-	3	-	-	-	-	-	-	-	-	-			
VPA4R[5]-4J[9]	-	4	-	-	-	-	-	-	-	-	-			
VPA6R[5]-4J[9]	4	6	M8 × 0.75	31.8	7	9.5	-	10.9	10	-	2			
VPA6R[5]-6J[9]	6		M10 × 1	32.6				11.7	12		3			
VPA8R[5]-4J[9]	4	8	M8 × 0.75	30.3	5.5	8	-	10.9	10	-	2			
VPA8R[5]-6J[9]	6		M10 × 1	31.1				11.7	12		3			
VPA10R[5]-6J[9]	-	10	-	34.1	8	12	-	-	-	-	-			
VPA15R(A)[5]-6J[9]	-	15	-	35.1(36.1)	9(10)	13(14)	-	-	-	-	-			
VPA20R(A)[5]-3J	3	20	-	46.7(47.7)	10(11)	16(17)	-	-	-	-	-			
VPA20R(A)[5]-4J[9]	4		-	37.7(38.7)								-	-	-
VPA20R(A)[5]-6J[9]	-		-	-								-	-	-
VPA25R(A)[5]-3J	3	25	-	47.7(48.7)	11(12)	17(18)	-	-	-	-	-			
VPA25R(A)[5]-4J[9]	4		-	38.7(39.7)								-	-	-
VPA25R(A)[5]-6J[9]	-		-	-								-	-	-
VPA30R(A)[5]-3J	3	30	-	47.7(50.7)	11(14)	17(20)	-	-	-	-	-			
VPA30R(A)[5]-4J[9]	4		-	38.7(41.7)								-	-	-
VPA30R(A)[5]-6J[9]	-		-	-								-	-	-
VPA40R(A)[5]-3J	3	40	-	50.7(54.2)	14(17.5)	20(23.5)	-	-	-	-	-			
VPA40R(A)[5]-4J[9]	4		-	41.7(45.2)								-	-	-
VPA40R(A)[5]-6J[9]	-		-	-								-	-	-
VPA50R(A)[5]-3J	3	50	-	51.7(54.7)	15(18)	21(24)	-	-	-	-	-			
VPA50R(A)[5]-4J[9]	4		-	42.7(45.7)								-	-	-
VPA50R(A)[5]-6J[9]	-		-	-								-	-	-
VPA60R(A)[5]-4J	4	60	-	61.3(68.3)	18(25)	30.6(37.6)	20	10.9	24	22	5			
VPA60R(A)[5]-6J	6		M20 × 1	63.6(70.6)				11.7						
VPA60R(A)[5]-8J	8		-	72.2(79.2)				18.2						
VPA80R(A)[5]-4J	4	80	-	63.7(73.7)	23(33)	33(43)	20	10.9	24	22	5			
VPA80R(A)[5]-6J	6		M20 × 1	66(76)				11.7						
VPA80R(A)[5]-8J	8		-	74.6(84.6)				18.2						
VPA100R(A)[5]-4J	4	100	-	65.7(74.7)	25(34)	35(44)	20	10.9	24	22	5			
VPA100R(A)[5]-6J	6		M20 × 1	68(77)				11.7						
VPA100R(A)[5]-8J	8		-	76.6(85.6)				18.2						
VPA150R[5]-6J	6	150	-	111.4	45	65	30	17	30	27	10			
VPA150R[5]-8J	8		M24 × 2	112.1				18.2						
VPA150R[5]-10J	10		-	119.1				20.7						
VPA150R[5]-12J	12		-	124.3				23.3						
VPA200R[5]-6J	6	200	-	116.4	50	70	30	17	30	27	10			
VPA200R[5]-8J	8		M24 × 2	117.1				18.2						
VPA200R[5]-10J	10		-	124.1				20.7						
VPA200R[5]-12J	12		-	129.3				23.3						

※ Value in () is the dimension of a deep type pad.

※ [5] : Replaced with Pad rubber material code. Refer to page 492 for details.

※ [9] Replaced with "-S3" for -S3 spec. (Copper alloy free material for metal parts and FKM or HNBR for sealing parts). -S3 spec. is available for model codes with [9] in the table above.

※ Tightening torque of a pad holder fixing bulkhead nut is as below.

Pad dia. (mm)	ø1~ø4	ø6, ø8	ø10, ø15	ø20~ø50	ø60~ø100	ø150, ø200
Tightening torque (N·m)	2~3	5~7	12~14	18~21	19~21	40~50

※ See Pisco website for weight information.



VPA Fixed type / Top port / Barb fitting / Standard holder

RoHS Compliant ~~Copper alloy~~ free available CAD (2D&3D)

VPA1R[5]-4B[9]

VPA2R[5]-4B[9]

VPA3R[5]-4B[9]

VPA4R[5]-4B[9]

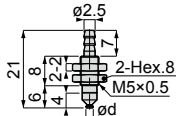

VPA6R[5][6][9]

VPA8R[5][6][9]

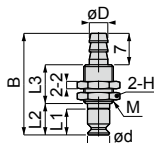

VPA10R[5]-6B[9]

VPA15R(A)[5]-6B[9]

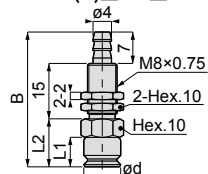

VPA20R(A)[5][6][9]

VPA25R(A)[5][6][9]

VPA30R(A)[5][6][9]

VPA40R(A)[5][6][9]

VPA50R(A)[5][6][9]

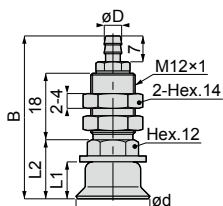

Unit : mm

Model code	Pad O.D. ød	Tube I.D. øD	Thread M	B	L1	L2	L3	Hex. H	Connection config. code
VPA1R[5]-4B[9]	1	-	-	-	-	-	-	-	-H3
VPA2R[5]-4B[9]	2	-	-	-	-	-	-		
VPA3R[5]-4B[9]	3	-	-	-	-	-	-		
VPA4R[5]-4B[9]	4	-	-	-	-	-	-		
VPA6R[5]-4B[9]	6	2.5	M5×0.5	24.5	7	9.5	8	8	-T8
VPA6R[5]-6B[9]		4	M8×0.75	26		8.5	10.5	10	
VPA6R[5]-4B[9]	8	2.5	M5×0.5	23	5.5	8	8	8	
VPA8R[5]-6B[9]		4	M8×0.75	24.5		7	10.5	10	
VPA10R[5]-6B[9]	10	-	-	35	8	13	-	-	-M4
VPA15R(A)[5]-6B[9]	15	-	-	36(37)	9(10)	14(15)	-	-	
VPA20R(A)[5]-4B[9]	20	2.5	-	44(45)	10(11)	16(17)	-	-	-M6
VPA20R(A)[5]-6B[9]		4	-				-	-	
VPA25R(A)[5]-4B[9]	25	2.5	-	45(46)	11(12)	17(18)	-	-	
VPA25R(A)[5]-6B[9]		4	-				-	-	
VPA30R(A)[5]-4B[9]	30	2.5	-	45(48)	11(14)	17(20)	-	-	
VPA30R(A)[5]-6B[9]		4	-				-	-	
VPA40R(A)[5]-4B[9]	40	2.5	-	48(51.5)	14(17.5)	20(23.5)	-	-	
VPA40R(A)[5]-6B[9]		4	-				-	-	
VPA50R(A)[5]-4B[9]	50	2.5	-	49(52)	15(18)	21(24)	-	-	
VPA50R(A)[5]-6B[9]		4	-				-	-	

※ . Value in () is the dimension of a deep type pad.

※ [5] : Replaced with Pad rubber material code. Refer to page 492 for details.

※ [9] : Replaced with "-S3" for -S3 spec. (Copper alloy free material for metal parts and FKM or HNBR for sealing parts).

※ . Pad material N, NE, and G are not suitable for use under ozone environment.

※ . Tightening torque of a pad holder fixing bulkhead nut is as below.

Pad dia. (mm)	ø1~ø4	ø6~ø15	ø20~ø50
Tightening torque (N·m)	1.5~2	2.5~3.5	12~14

※ . See Pisco website for weight information.

VPA Fixed type / Top port / Female thread / Standard holder

RoHS Compliant ~~Copper alloy free available~~ CAD (2D&3D)

VPA20R(A) [5]-M6 [9]
VPA25R(A) [5]-M6 [9]
VPA30R(A) [5]-M6 [9]
VPA40R(A) [5]-M6 [9]
VPA50R(A) [5]-M6 [9]

Connection
config. code
-M6

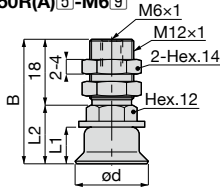

VPA60R(A) [5]-G1 [9]
VPA80R(A) [5]-G1 [9]
VPA100R(A) [5]-G1 [9]
VPA150R [5]-G2 [9]
VPA200R [5]-G2 [9]

Connection
config. code
-M10

Connection
config. code
-M20

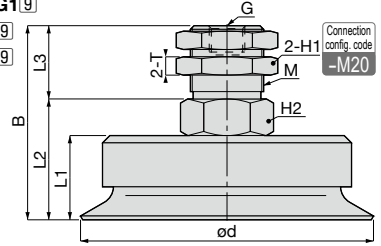

Unit : mm

Model code	Port size G	Pad O.D. ød	Thread M	B	L1	L2	L3	T	Hex. H1	Hex. H2
VPA20R(A) [5]-M6 [9]	-	20	-	34(35)	10(11)	16(17)	-	-	-	-
VPA25R(A) [5]-M6 [9]	-	25	-	35(36)	11(12)	17(18)	-	-	-	-
VPA30R(A) [5]-M6 [9]	-	30	-	35(38)	11(14)	17(20)	-	-	-	-
VPA40R(A) [5]-M6 [9]	-	40	-	38(41.5)	14(17.5)	20(23.5)	-	-	-	-
VPA50R(A) [5]-M6 [9]	-	50	-	39(42)	15(18)	21(24)	-	-	-	-
VPA60R(A) [5]-G1 [9]	G1/8	60	M20×1	50.6(57.6)	18(25)	30.6(37.6)	20	5	24	22
VPA80R(A) [5]-G1 [9]	G1/8	80	M20×1	53(63)	23(33)	33(43)	20	5	24	22
VPA100R(A) [5]-G1 [9]	G1/8	100	M20×1	55(64)	25(34)	35(44)	20	5	24	22
VPA150R [5]-G2 [9]	G1/4	150	M24×2	95	45	65	30	10	30	27
VPA200R [5]-G2 [9]	G1/4	200	M24×2	100	50	70	30	10	30	27

- ※ . Value in () is the dimension of a deep type pad.
- ※ [5] : Replaced with Pad rubber material code. Refer to page 492 for details.
- ※ [9] : Replaced with "-S3" for -S3 spec. (Copper alloy free material for metal parts and FKM or HNBR for sealing parts).
- ※ . Pad material N, NE, and G are not suitable for use under ozone environment.
- ※ . Tightening torque of a pad holder fixing bulkhead nut is as below.

Pad dia. (mm)	ø20~ø50	ø60~ø100	ø150, ø200
Tightening torque (N·m)	12~14	19~21	40~50

- ※ . See Pisco website for weight information.



VPMB Fixed type / Side port / Push-in fitting / Mini holder

VPMB0.7RM [5][6][9]

VPMB1RM [5][6][9]

VPMB1.5RM [5][6][9]

VPMB2RM [5][6][9]

VPMB3RM [5][6][9]

VPMB4RM [5][6][9]

VPMB6R [5][6][9]

VPMB8R [5][6][9]

VPMB10R [5][6][9]

VPMB15R(A) [5][6][9]

VPMB20R(A) [5][6][9]

VPMB25R(A) [5][6][9]

VPMB30R(A) [5][6][9]

VPMB40R(A) [5][6][9]

VPMB50R(A) [5][6][9]

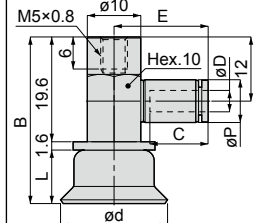
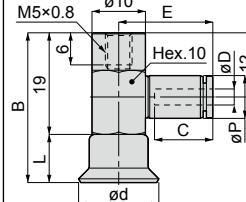
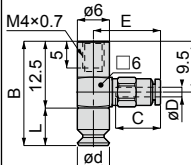
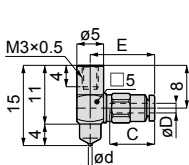

Unit : mm

Model code	Tube O.D. øD	Pad O.D. ød	B	L	Tube end C	E	Connection config. code
VPMB0.7RM[5]-180J	1.8	0.7	—	—	8.4	12	-T4
VPMB0.7RM[5]-2J	2				9.4	13	
VPMB0.7RM[5]-3J	3				10.9	15	
VPMB0.7RM[5]-4J[9]	4						
VPMB1RM[5]-180J	1.8	1	—	—	8.4	12	
VPMB1RM[5]-2J	2				9.4	13	
VPMB1RM[5]-3J	3				10.9	15	
VPMB1RM[5]-4J9	4						
VPMB1.5RM[5]-180J	1.8	1.5	—	—	8.4	12	
VPMB1.5RM[5]-2J	2				9.4	13	
VPMB1.5RM[5]-3J	3				10.9	15	
VPMB1.5RM[5]-4J[9]	4						
VPMB2RM[5]-180J	1.8	2	—	—	8.4	12	
VPMB2RM[5]-2J	2				9.4	13	
VPMB2RM[5]-3J	3				10.9	15	
VPMB2RM[5]-4J[9]	4						
VPMB3RM[5]-180J	1.8	3	—	—	8.4	12	
VPMB3RM[5]-2J	2				9.4	13	
VPMB3RM[5]-3J	3				10.9	15	
VPMB3RM[5]-4J[9]	4						
VPMB4RM[5]-180J	1.8	4	—	—	8.4	12	
VPMB4RM[5]-2J	2				9.4	13	
VPMB4RM[5]-3J	3				10.9	15	
VPMB4RM[5]-4J[9]	4						
VPMB6R[5]-180J	1.8	6	19.5	7	8.4	12.5	-T8
VPMB6RM[5]-2J	2				9.4	13.5	
VPMB6R[5]-3J	3				10.9	15.5	
VPMB6RM[5]-4J[9]	4						
VPMB8R[5]-180J	1.8	8	18	5.5	8.4	12.5	
VPMB8RM[5]-2J	2				9.4	13.5	
VPMB8R[5]-3J	3				10.9	15.5	
VPMB8RM[5]-4J[9]	4						

RoHS Compliant ~~X~~ Copper alloy free available  CAD (2D&3D)

Unit : mm

Model code	Tube O.D. øD	Pad O.D. ød	B	L	Tube end C	E	Connection config. code
VPMB10R()-180J	1.8	10	27	8	8.4	13.7	-M4
VPMB10R()-2J	2						
VPMB10R()-3J	3				10.9	17.5	
VPMB10R()-4J()	4						
VPMB10R()-6J()	6	11.7	19.4				
VPMB15R(A)-180J	1.8	15	28(29)	9(10)	8.4	13.7	
VPMB15R(A)-2J	2						
VPMB15R(A)-3J	3				10.9	17.5	
VPMB15R(A)-4J()	4						
VPMB15R(A)-6J()	6	11.7	19.4				
VPMB20R(A)-180J	1.8	20	31.2(32.2)	10(11)	8.4	13.7	-M6
VPMB20R(A)-2J	2						
VPMB20R(A)-3J	3				10.9	17.5	
VPMB20R(A)-4J()	4						
VPMB20R(A)-6J()	6	11.7	19.4				
VPMB25R(A)-180J	1.8	25	32.2(33.2)	11(12)	8.4	13.7	
VPMB25R(A)-2J	2						
VPMB25R(A)-3J	3				10.9	17.5	
VPMB25R(A)-4J()	4						
VPMB25R(A)-6J()	6	11.7	19.4				
VPMB30R(A)-180J	1.8	30	32.2(35.2)	11(14)	8.4	13.7	
VPMB30R(A)-2J	2						
VPMB30R(A)-3J	3				10.9	17.5	
VPMB30R(A)-4J()	4						
VPMB30R(A)-6J()	6	11.7	19.4				
VPMB40R(A)-180J	1.8	40	35.2(38.7)	14(17.5)	8.4	13.7	
VPMB40R(A)-2J	2						
VPMB40R(A)-3J	3				10.9	17.5	
VPMB40R(A)-4J()	4						
VPMB40R(A)-6J()	6	11.7	19.4				
VPMB50R(A)-180J	1.8	50	36.2(39.2)	15(18)	8.4	13.7	
VPMB50R(A)-2J	2						
VPMB50R(A)-3J	3				10.9	17.5	
VPMB50R(A)-4J()	4						
VPMB50R(A)-6J()	6	11.7	19.4				

※. Value in () is the dimension of a deep type pad.

※. () : Replaced with Pad rubber material code. Refer to page 492 for details.

※. () : Replaced with "-S3" for -S3 spec. (Copper alloy free material for metal parts and FKM or HNBR for sealing parts). -S3 spec. is available for model codes with () in the table above.

※. Pad material N, NE, and G are not suitable for use under ozone environment.

※. See Pisco website for weight information.



VPMB Fixed type / Side port / Barb fitting / Mini holder

VPMB0.7RM [5][6][9]

VPMB1RM [5][6][9]

VPMB1.5RM [5][6][9]

VPMB2RM [5][6][9]

VPMB3RM [5][6][9]

VPMB4RM [5][6][9]

VPMB6R [5][6][9]

VPMB8R [5][6][9]

VPMB10R [5][6][9]

VPMB15R(A) [5][6][9]

VPMB20R(A) [5][6][9]

VPMB25R(A) [5][6][9]

VPMB30R(A) [5][6][9]

VPMB40R(A) [5][6][9]

VPMB50R(A) [5][6][9]

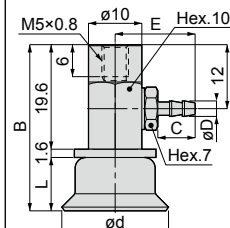
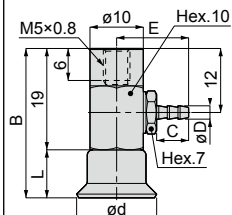
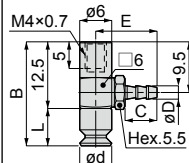
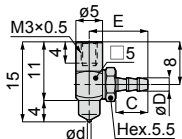

Unit : mm

Model code	Tube I.D. ØD	Pad O.D. Ød	B	L	E	C	Connection config. code
VPMB0.7RM[5]-3B[9]	2	0.7	—	—	10.9	6	-T4
VPMB0.7RM[5]-4B[9]	2.5				11.9	7	
VPMB0.7RM[5]-6B[9]	4				11.9	7	
VPMB1RM[5]-3B[9]	2	1	—	—	10.9	6	
VPMB1RM[5]-4B[9]	2.5				11.9	7	
VPMB1RM[5]-6B[9]	4				11.9	7	
VPMB1.5RM[5]-3B[9]	2	1.5	—	—	10.9	6	
VPMB1.5RM[5]-4B[9]	2.5				11.9	7	
VPMB1.5RM[5]-6B[9]	4				11.9	7	
VPMB2RM[5]-3B[9]	2	2	—	—	10.9	6	
VPMB2RM[5]-4B[9]	2.5				11.9	7	
VPMB2RM[5]-6B[9]	4				11.9	7	
VPMB3RM[5]-3B[9]	2	3	—	—	10.9	6	
VPMB3RM[5]-4B[9]	2.5				11.9	7	
VPMB3RM[5]-6B[9]	4				11.9	7	
VPMB4RM[5]-3B[9]	2	4	—	—	10.9	6	
VPMB4RM[5]-4B[9]	2.5				11.9	7	
VPMB4RM[5]-6B[9]	4				11.9	7	
VPMB6R[5]-3B[9]	2	6	19.5	7	11.4	6	-T8
VPMB6R[5]-4B[9]	2.5				12.4	7	
VPMB6R[5]-6B[9]	4				11.4	6	
VPMB8R[5]-3B[9]	2	8	18	5.5	11.4	6	
VPMB8R[5]-4B[9]	2.5				12.4	7	
VPMB8R[5]-6B[9]	4				11.4	6	
VPMB10R[5]-3B[9]	2	10	27	8	13.4	6	-M4
VPMB10R[5]-4B[9]	2.5				14.9	7	
VPMB10R[5]-6B[9]	4				13.4	6	
VPMB15R(A)[5]-3B[9]	2	15	28(29)	9(10)	13.4	6	
VPMB15R(A)[5]-4B[9]	2.5				14.9	7	
VPMB15R(A)[5]-6B[9]	4				14.9	7	

RoHS Compliant ~~Copper alloy free available~~ CAD (2D&3D)

Unit : mm

Model code	Tube I.D. øD	Pad O.D. ød	B	L	E	C	Connection config. code
VPMB20R(A)S-3B9	2	20	31.2(32.2)	10(11)	13.4	6	-M6
VPMB20R(A)S-4B9	2.5				14.9	7	
VPMB20R(A)S-6B9	4						
VPMB25R(A)S-3B9	2	25	32.2(33.2)	11(12)	13.4	6	
VPMB25R(A)S-4B9	2.5				14.9	7	
VPMB25R(A)S-6B9	4						
VPMB30R(A)S-3B9	2	30	32.2(35.2)	11(14)	13.4	6	
VPMB30R(A)S-4B9	2.5				14.9	7	
VPMB30R(A)S-6B9	4						
VPMB40R(A)S-3B9	2	40	35.2(38.7)	14(17.5)	13.4	6	
VPMB40R(A)S-4B9	2.5				14.9	7	
VPMB40R(A)S-6B9	4						
VPMB50R(A)S-3B9	2	50	36.2(39.2)	15(18)	13.4	6	
VPMB50R(A)S-4B9	2.5				14.9	7	
VPMB50R(A)S-6B9	4						

※ .Value in () is the dimension of a deep type pad.

※ [S] : Replaced with Pad rubber material code. Refer to page 492 for details.

※ [9] : Replaced with "-S3" for -S3 spec. (Copper alloy free material for metal parts and FKM or HNBR for sealing parts).

※ .Pad material N, NE, and G are not suitable for use under ozone environment.

※ .See Pisco website for weight information.

VPMB Fixed type / Side port / Female thread / Mini holder

RoHS Compliant ~~Copper~~ alloy free available CAD (2D&3D)



VPMB0.7RM[5]-M3[9]
 VPMB1RM[5]-M3[9]
 VPMB1.5RM[5]-M3[9]
 VPMB2RM[5]-M3[9]
 VPMB3RM[5]-M3[9]
 VPMB4RM[5]-M3[9]

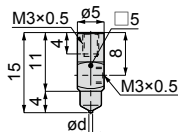

VPMB6R[5]-M3[9]
 VPMB8R[5]-M3[9]

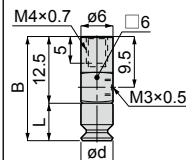

VPMB10R[5]-M5[9]
 VPMB15R(A)[5]-M5[9]

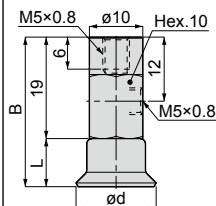

VPMB20R(A)[5]-M5[9]
 VPMB25R(A)[5]-M5[9]
 VPMB30R(A)[5]-M5[9]
 VPMB40R(A)[5]-M5[9]
 VPMB50R(A)[5]-M5[9]

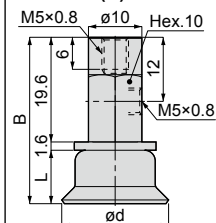

Unit : mm

Model code	Pad O.D. ød	B	L	Connection config. code
VPMB0.7RM[5]-M3[9]	0.7	—	—	-T4
VPMB1RM[5]-M3[9]	1	—	—	
VPMB1.5RM[5]-M3[9]	1.5	—	—	
VPMB2RM[5]-M3[9]	2	—	—	
VPMB3RM[5]-M3[9]	3	—	—	
VPMB4RM[5]-M3[9]	4	—	—	
VPMB6R[5]-M3[9]	6	19.5	7	-T8
VPMB8R[5]-M3[9]	8	18	5.5	
VPMB10R[5]-M5[9]	10	27	8	-M4
VPMB15R(A)[5]-M5[9]	15	28(29)	9(10)	
VPMB20R(A)[5]-M5[9]	20	31.2(32.2)	10(11)	-M6
VPMB25R(A)[5]-M5[9]	25	32.2(33.2)	11(12)	
VPMB30R(A)[5]-M5[9]	30	32.2(35.2)	11(14)	
VPMB40R(A)[5]-M5[9]	40	35.2(38.7)	14(17.5)	
VPMB50R(A)[5]-M5[9]	50	36.2(39.2)	15(18)	

※ Value in () is the dimension of a deep type pad.

※ [5] : Replaced with Pad rubber material code. Refer to page 492 for details.

※ [9] : Replaced with "-S3" for -S3 spec. (Copper alloy free material for metal parts and FKM or HNBR for sealing parts).

※ Pad material N, NE, and G are not suitable for use under ozone environment.

※ See Pisco website for weight information.

VPB Fixed type / Side port / Push-in fitting / Standard holder

RoHS Compliant Copper alloy free available CAD (2D&3D)

VPB1R^{[5][6][9]}
VPB2R^{[5][6][9]}
VPB3R^{[5][6][9]}
VPB4R^{[5][6][9]}

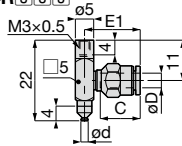

VPB6R^{[5][6][9]}
VPB8R^{[5][6][9]}

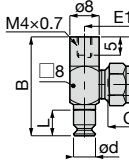

VPB10R^{[5][6][9]}
VPB15R(A)^{[5][6][9]}

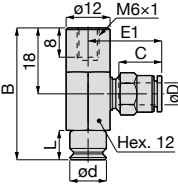

Unit : mm

Model code	Tube O.D. øD	Pad O.D. ød	B	L	Tube end C	E1	Connection config. code	
VPB1R ^[5] -180J	1.8	1	—	—	8.4	12	-H3	
VPB1R ^[5] -2J	2				9.4	13		
VPB1R ^[5] -3J	3				10.9	15		
VPB1R ^[5] -4J ^[9]	4				8.4	12		
VPB2R ^[5] -180J	1.8	2	—	—	8.4	12		
VPB2R ^[5] -2J	2				9.4	13		
VPB2R ^[5] -3J	3				10.9	15		
VPB2R ^[5] -4J ^[9]	4				8.4	12		
VPB3R ^[5] -180J	1.8	3	—	—	8.4	12		
VPB3R ^[5] -2J	2				9.4	13		
VPB3R ^[5] -3J	3				10.9	15		
VPB3R ^[5] -4J ^[9]	4				8.4	12		
VPB4R ^[5] -180J	1.8	4	—	—	8.4	12		
VPB4R ^[5] -2J	2				9.4	13		
VPB4R ^[5] -3J	3				10.9	15		
VPB4R ^[5] -4J ^[9]	4				8.4	12.7		
VPB6R ^[5] -180J	1.8	6	27	7	8.4	12.7	-T8	
VPB6R ^[5] -2J	2				10.9	16.5		
VPB6R ^[5] -3J	3				11.7	18.4		
VPB6R ^[5] -4J ^[9]	4				8.4	12.7		
VPB6R ^[5] -6J ^[9]	6	8.4	12.7					
VPB8R ^[5] -180J	1.8	8	25.5	5.5	10.9	16.5		
VPB8R ^[5] -2J	2				11.7	18.4		
VPB8R ^[5] -3J	3				8.4	12.7		
VPB8R ^[5] -4J ^[9]	4				10.9	16.5		
VPB8R ^[5] -6J ^[9]	6	11.7	18.4					
VPB10R ^[5] -3J	3	10	36	8	10.9	18.6		-M4
VPB10R ^[5] -4J ^[9]	4				11.7	19.9		
VPB10R ^[5] -6J ^[9]	6				10.9	18.6		
VPB15R(A) ^[5] -3J	3	15	37(38)	9(10)	10.9	18.6		
VPB15R(A) ^[5] -4J ^[9]	4				11.7	19.9		
VPB15R(A) ^[5] -6J ^[9]	6				10.9	18.6		

※ ^[5] : Replaced with Pad rubber material code. Refer to page 492 for details.

※ ^[9] : Replaced with "-S3" for -S3 spec. (Copper alloy free material for metal parts and FKM or HNBR for sealing parts). -S3 spec. is available for model codes with ^[9] in the table above.

※ Pad material N, NE, and G are not suitable for use under ozone environment.

※ See Pisco website for weight information.



Vacuum Pad Series

Vacuum Pad Standard Series

RoHS Compliant ~~X~~ Copper alloy free available ~~✂~~ CAD (2D&3D)

VPB20R(A) 5 6 9
 VPB25R(A) 5 6 9
 VPB30R(A) 5 6 9
 VPB40R(A) 5 6 9
 VPB50R(A) 5 6 9

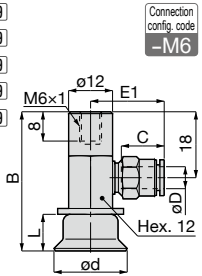

Connection
config. code
-M6

VPB60R(A) 5 6 9
 VPB80R(A) 5 6 9
 VPB100R(A) 5 6 9
 VPB150R 5 6 9
 VPB200R 5 6 9

Connection
config. code
-M10

Connection
config. code
-M20

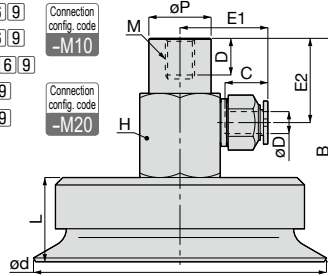

Unit : mm

Model code	Tube O.D. ød	Pad O.D. øD	Thread M	B	L	Tube end C	øP	D	E1	E2	Hex. H
VPB20R(A) 5-3J	3	20	-	38(39)	10(11)	10.9	-	-	18.6	-	-
VPB20R(A) 5-4J 9	4					11.7			19.9		
VPB20R(A) 5-6J 9	6					11.7			19.9		
VPB25R(A) 5-3J	3	25	-	39(40)	11(12)	10.9	-	-	18.6	-	-
VPB25R(A) 5-4J 9	4					11.7			19.9		
VPB25R(A) 5-6J 9	6					11.7			19.9		
VPB30R(A) 5-3J	3	30	-	39(42)	11(14)	10.9	-	-	18.6	-	-
VPB30R(A) 5-4J 9	4					11.7			19.9		
VPB30R(A) 5-6J 9	6					11.7			19.9		
VPB40R(A) 5-3J	3	40	-	42(45.5)	14(17.5)	10.9	-	-	18.6	-	-
VPB40R(A) 5-4J 9	4					11.7			19.9		
VPB40R(A) 5-6J 9	6					11.7			19.9		
VPB50R(A) 5-3J	3	50	-	43(46)	15(18)	10.9	-	-	18.6	-	-
VPB50R(A) 5-4J 9	4					11.7			19.9		
VPB50R(A) 5-6J 9	6					11.7			19.9		
VPB60R(A) 5-4J 9	4	60	M8×1.25	58.6(65.6)	18(25)	10.9	17	10	21.6	23	22
VPB60R(A) 5-6J 9	6					11.7			23.9		
VPB60R(A) 5-8J 9	8					18.2			32.5		
VPB80R(A) 5-4J 9	4	80	M8×1.25	61(71)	23(33)	10.9	17	10	21.6	23	22
VPB80R(A) 5-6J 9	6					11.7			23.9		
VPB80R(A) 5-8J 9	8					18.2			32.5		
VPB100R(A) 5-4J 9	4	100	M8×1.25	63(72)	25(34)	10.9	17	10	22.4	23	22
VPB100R(A) 5-6J 9	6					11.7			23.9		
VPB100R(A) 5-8J 9	8					18.2			32.5		
VPB150R 5-6J 9	6	150	M16×2	110	45	17	26	20	31.3	40	30
VPB150R 5-8J 9	8					18.2			32		
VPB150R 5-10J 9	10					20.7			39		
VPB200R 5-6J 9	6	200	M16×2	115	50	17	26	20	31.3	40	30
VPB200R 5-8J 9	8					18.2			32		
VPB200R 5-10J 9	10					20.7			39		

※ Value in () is the dimension of a deep type pad.

※ 5: Replaced with Pad rubber material code. Refer to page 492 for details.

※ 9: Replaced with "-S3" for -S3 spec. (Copper alloy free material for metal parts and FKM or HNBR for sealing parts). -S3 spec. is available for model codes with 9 in the table above.

※ Pad material N, NE, and G are not suitable for use under ozone environment.

※ See Pisco website for weight information.

VPB Fixed type / Side port / Barb fitting / Standard holder

RoHS Compliant Copper alloy free available  CAD (2D&3D)

VPB1R [5][6][9]
VPB2R [5][6][9]
VPB3R [5][6][9]
VPB4R [5][6][9]

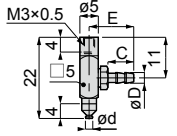

VPB6R [5][6][9]
VPB8R [5][6][9]

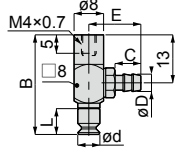

VPB10R [5][6][9]
VPB15R(A) [5][6][9]

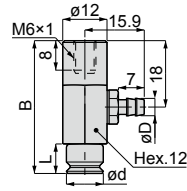

VPB20R(A) [5][6][9]
VPB25R(A) [5][6][9]
VPB30R(A) [5][6][9]
VPB40R(A) [5][6][9]
VPB50R(A) [5][6][9]

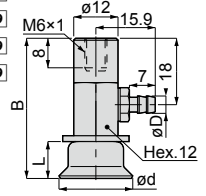

Unit : mm

Model code	Tube I.D. øD	Pad O.D. ød	B	L	C	E	Connection config. code
VPB1R [5]-3B [9]	2	1	-	-	6	10.9	-H3
VPB1R [5]-4B [9]	2.5				7	11.9	
VPB1R [5]-6B [9]	4				7	11.9	
VPB2R [5]-3B [9]	2	2	-	-	6	10.9	
VPB2R [5]-4B [9]	2.5				7	11.9	
VPB2R [5]-6B [9]	4				7	11.9	
VPB3R [5]-3B [9]	2	3	-	-	6	10.9	
VPB3R [5]-4B [9]	2.5				7	11.9	
VPB3R [5]-6B [9]	4				7	11.9	
VPB4R [5]-3B [9]	2	4	-	-	6	10.9	
VPB4R [5]-4B [9]	2.5				7	11.9	
VPB4R [5]-6B [9]	4				7	11.9	
VPB6R [5]-3B [9]	2	6	27	7	6	12.4	-T8
VPB6R [5]-4B [9]	2.5				7	13.9	
VPB6R [5]-6B [9]	4				7	13.9	
VPB8R [5]-3B [9]	2	8	25.5	5.5	6	12.4	
VPB8R [5]-4B [9]	2.5				7	13.9	
VPB8R [5]-6B [9]	4				7	13.9	
VPB10R [5]-4B [9]	2.5	10	36	8	-	-	-M4
VPB10R [5]-6B [9]	4				-	-	
VPB15R(A) [5]-4B [9]	2.5	15	37(38)	9(10)	-	-	-
VPB15R(A) [5]-6B [9]	4				-	-	
VPB20R(A) [5]-4B [9]	2.5	20	38(39)	10(11)	-	-	-
VPB20R(A) [5]-6B [9]	4				-	-	
VPB25R(A) [5]-4B [9]	2.5	25	39(40)	11(12)	-	-	-
VPB25R(A) [5]-6B [9]	4				-	-	
VPB30R(A) [5]-4B [9]	2.5	30	39(42)	11(14)	-	-	-M6
VPB30R(A) [5]-6B [9]	4				-	-	
VPB40R(A) [5]-4B [9]	2.5	40	42(45.5)	14(17.5)	-	-	
VPB40R(A) [5]-6B [9]	4				-	-	
VPB50R(A) [5]-4B [9]	2.5	50	43(46)	15(18)	-	-	
VPB50R(A) [5]-6B [9]	4				-	-	

※ Value in () is the dimension of a deep type pad.

※ [5] : Replaced with Pad rubber material code. Refer to page 492 for details.

※ [9] : Replaced with "-S3" for -S3 spec. (Copper alloy free material for metal parts and FKM or HNBR for sealing parts). -S3 spec. is available for model codes with [9] in the table above.

※ Pad material N, NE, and G are not suitable for use under ozone environment.

※ See Pisco website for weight information.



VPB Fixed type / Side port / Female thread / Standard holder

VPB1R^[5]-M3^[9]

VPB2R^[5]-M3^[9]

VPB3R^[5]-M3^[9]

VPB4R^[5]-M3^[9]

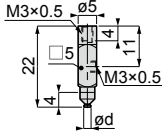

VPB6R^[5]-M5^[9]

VPB8R^[5]-M5^[9]

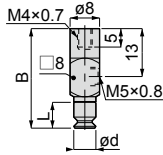

VPB10R^[5]-M6^[9]

VPB15R(A)^[5]-M6^[9]

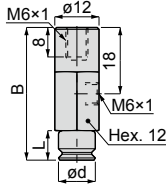

VPB20R(A)^[5]-M6^[9]

VPB25R(A)^[5]-M6^[9]

VPB30R(A)^[5]-M6^[9]

VPB40R(A)^[5]-M6^[9]

VPB50R(A)^[5]-M6^[9]

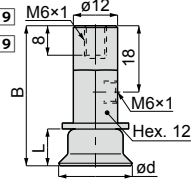

VPB60R(A)^[5]-G1^[9]

VPB80R(A)^[5]-G1^[9]

VPB100R(A)^[5]-G1^[9]

VPB150R^[5]-G2^[9]

VPB200R^[5]-G2^[9]

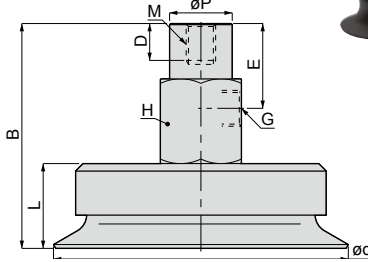

RoHS Compliant

Copper alloy free available

CAD (2D&3D)

Unit : mm

Model code	Port size G	Pad O.D. ød	Thread M	B	L	E	Connection config. code
VPB1R ^[5] -M3 ^[9]	-	1	-	-	-	-	-H3
VPB2R ^[5] -M3 ^[9]	-	2	-	-	-	-	
VPB3R ^[5] -M3 ^[9]	-	3	-	-	-	-	
VPB4R ^[5] -M3 ^[9]	-	4	-	-	-	-	
VPB6R ^[5] -M5 ^[9]	-	6	-	27	7	-	-T8
VPB8R ^[5] -M5 ^[9]	-	8	-	25.5	5.5	-	-
VPB10R ^[5] -M6 ^[9]	-	10	-	36	8	-	-M4
VPB15R(A) ^[5] -M6 ^[9]	-	15	-	37(38)	9(10)	-	-
VPB20R(A) ^[5] -M6 ^[9]	-	20	-	38(39)	10(11)	-	-
VPB25R(A) ^[5] -M6 ^[9]	-	25	-	39(40)	11(12)	-	-
VPB30R(A) ^[5] -M6 ^[9]	-	30	-	39(42)	11(14)	-	-M6
VPB40R(A) ^[5] -M6 ^[9]	-	40	-	42(45.5)	14(17.5)	-	-
VPB50R(A) ^[5] -M6 ^[9]	-	50	-	43(46)	15(18)	-	-
VPB60R(A) ^[5] -G1 ^[9]	G1/8	60	M8×1.25	58.6(65.6)	18(25)	23	-M10
VPB80R(A) ^[5] -G1 ^[9]	G1/8	80	M8×1.25	61(71)	23(33)	23	
VPB100R(A) ^[5] -G1 ^[9]	G1/8	100	M8×1.25	63(72)	25(34)	23	
VPB150R ^[5] -G2 ^[9]	G1/4	150	M16×2	110	45	40	-M20
VPB200R ^[5] -G2 ^[9]	G1/4	200	M16×2	115	50	40	

※ . Value in () is the dimension of a deep type pad.

※ [5] : Replaced with Pad rubber material code. Refer to page 492 for details.

※ [9] : Replaced with "-S3" for -S3 spec. (Copper alloy free material for metal parts and FKM or HNBR for sealing parts). -S3 spec. is available for model codes with [9] in the table above.

※ . Pad material N, NE, and G are not suitable for use under ozone environment.

※ . See Pisco website for weight information.

VPME Fixed type / Direct mount / Metric thread / Mini holder

RoHS Compliant ~~Copper alloy free available~~ CAD (2D&3D)



VPME0.7RM[5]-M3[9]
VPME1RM[5]-M3[9]
VPME1.5RM[5]-M3[9]
VPME2RM[5]-M3[9]
VPME3RM[5]-M3[9]
VPME4RM[5]-M3[9]

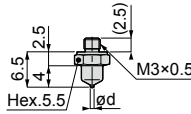

VPME6R[5]-M5[9]
VPME8R[5]-M5[9]

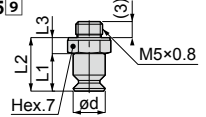

Unit : mm

Model code	Pad O.D. ød	L1	L2	Connection config. code
VPME0.7RM[5]-M3[9]	0.7	-	-	-T4
VPME1RM[5]-M3[9]	1	-	-	
VPME1.5RM[5]-M3[9]	1.5	-	-	
VPME2RM[5]-M3[9]	2	-	-	
VPME3RM[5]-M3[9]	3	-	-	
VPME4RM[5]-M3[9]	4	-	-	
VPME6R[5]-M5[9]	6	7	10	-T8
VPME8R[5]-M5[9]	8	5.5	8.5	

- ※ [5] : Replaced with Pad rubber material code. Refer to page 492 for details.
- ※ [9] : Replaced with "-S3" for -S3 spec. (Copper alloy free material for metal parts and FKM or HNBR for sealing parts).
- ※ .Pad material N, NE, and G are not suitable for use under ozone environment.
- ※ .Tightening torque for fixing a pad holder is as below.
- Pad dia. : ø0.7~ø4mm ▶ 0.7N·m. •Pad dia. : ø6, ø8mm ▶ 1~1.5N·m
- ※ .See Pisco website for weight information.

VPE Fixed type / Direct mount / Metric thread / Standard holder

RoHS Compliant ~~Copper alloy free available~~ CAD (2D&3D)



VPE1R[5]-M3[9]
VPE2R[5]-M3[9]
VPE3R[5]-M3[9]
VPE4R[5]-M3[9]

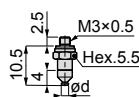

VPE6R[5]-M5[9]
VPE8R[5]-M5[9]

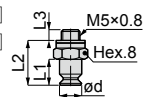

Unit : mm

Model code	Pad O.D. ød	L1	L2	Connection config. code
VPE1R[5]-M3[9]	1	—	—	-H3
VPE2R[5]-M3[9]	2	—	—	
VPE3R[5]-M3[9]	3	—	—	
VPE4R[5]-M3[9]	4	—	—	
VPE6R[5]-M5[9]	6	7	12	-T8
VPE8R[5]-M5[9]	8	5.5	10.5	

- ※ [5] : Replaced with Pad rubber material code. Refer to page 492 for details.
- ※ [9] : Replaced with "-S3" for -S3 spec. (Copper alloy free material for metal parts and FKM or HNBR for sealing parts).
- ※ .Pad material N, NE, and G are not suitable for use under ozone environment.
- ※ .Tightening torque for fixing a pad holder is as below.
- Pad dia. : ø0.7~ø4mm ▶ 0.7N·m. •Pad dia. : ø6, ø8mm ▶ 1~1.5N·m
- ※ .See Pisco website for weight information.



Vacuum pad + Spring type holder Dimensions

VPMC Spring type / Top port / Push-in fitting / Mini holder

VPMC0.7-2RM [5][6]

VPMC1-2RM [5][6]

VPMC1.5-2RM [5][6]

VPMC2-2RM [5][6]

VPMC3-2RM [5][6]

VPMC4-2RM [5][6]

VPMC6-2R [5][6]

VPMC8-2R [5][6]

VPMC10-4R [5][6][9]

VPMC15-4R(A) [5][6][9]

VPMC20-4R(A) [5][6][9]

VPMC25-4R(A) [5][6][9]

VPMC30-4R(A) [5][6][9]

VPMC40-4R(A) [5][6][9]

VPMC50-4R(A) [5][6][9]

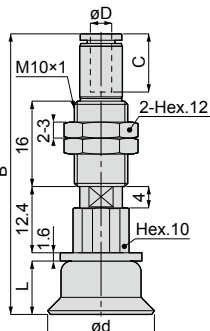
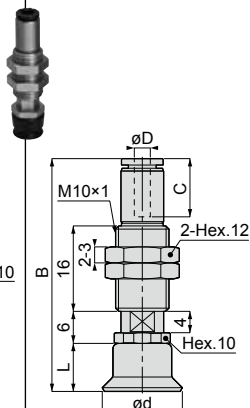
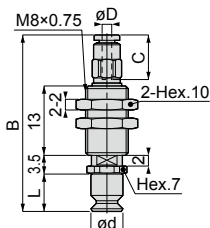
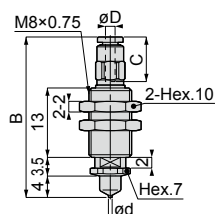

Unit : mm

Model code	Tube O.D. øD	Pad O.D. ød	B	L	Tube end C	Spring force (N)	Connection config. code
VPMC0.7-2RM [5]-180J	1.8	0.7	30.2	—	8.4	0.2 ~ 0.3	-T4
VPMC0.7-2RM [5]-2J	2						
VPMC0.7-2RM [5]-3J	3		31.2				
VPMC1-2RM [5]-180J	1.8	1	30.2	—	8.4	0.2 ~ 0.3	
VPMC1-2RM [5]-2J	2						
VPMC1-2RM [5]-3J	3		31.2				
VPMC1.5-2RM [5]-180J	1.8	1.5	30.2	—	8.4	0.2 ~ 0.3	
VPMC1.5-2RM [5]-2J	2						
VPMC1.5-2RM [5]-3J	3		31.2				
VPMC2-2RM [5]-180J	1.8	2	30.2	—	8.4	0.2 ~ 0.3	
VPMC2-2RM [5]-2J	2						
VPMC2-2RM [5]-3J	3		31.2				
VPMC3-2RM [5]-180J	1.8	3	30.2	—	8.4	0.2 ~ 0.3	
VPMC3-2RM [5]-2J	2						
VPMC3-2RM [5]-3J	3		31.2				
VPMC4-2RM [5]-180J	1.8	4	30.2	—	8.4	0.2 ~ 0.3	
VPMC4-2RM [5]-2J	2						
VPMC4-2RM [5]-3J	3		31.2				
VPMC6-2R [5]-180J	1.8	6	33.2	7	8.4	0.5 ~ 0.6	-T8
VPMC6-2R [5]-2J	2						
VPMC6-2R [5]-3J	3		34.2				
VPMC8-2R [5]-180J	1.8	8	31.7	5.5	8.4	0.5 ~ 0.6	
VPMC8-2R [5]-2J	2						
VPMC8-2R [5]-3J	3		32.7				

Stroke (mm)
2, 4

RoHS Compliant Copper alloy free available CAD (2D&3D)

Unit : mm

Model code	Tube O.D. øD	Pad O.D. ød	B	L	Tube end C	Spring force (N)	Connection config. code
VPMC10-4R(S)-180J	1.8	10	38.9	8	8.4	1 ~ 1.3	-M4
VPMC10-4R(S)-2J	2						
VPMC10-4R(S)-3J	3		42.7				
VPMC10-4R(S)-4J ^⑨	4						
VPMC15-4R(A)(S)-180J	1.8	15	39.9(40.9)	9(10)	8.4	1 ~ 1.3	
VPMC15-4R(A)(S)-2J	2						
VPMC15-4R(A)(S)-3J	3		43.7(44.7)				
VPMC15-4R(A)(S)-4J ^⑨	4						
VPMC20-4R(A)(S)-180J	1.8	20	48.9(49.9)	10(11)	8.4	1 ~ 1.3	
VPMC20-4R(A)(S)-2J	2						
VPMC20-4R(A)(S)-3J	3		52.7(53.7)				
VPMC20-4R(A)(S)-4J ^⑨	4						
VPMC25-4R(A)(S)-180J	1.8	25	49.9(50.9)	11(12)	8.4	1 ~ 1.3	
VPMC25-4R(A)(S)-2J	2						
VPMC25-4R(A)(S)-3J	3		53.7(54.7)				
VPMC25-4R(A)(S)-4J ^⑨	4						
VPMC30-4R(A)(S)-180J	1.8	30	49.9(52.9)	11(14)	8.4	1 ~ 1.3	
VPMC30-4R(A)(S)-2J	2						
VPMC30-4R(A)(S)-3J	3		53.7(56.7)				
VPMC30-4R(A)(S)-4J ^⑨	4						
VPMC40-4R(A)(S)-180J	1.8	40	52.9(56.4)	14(17.5)	8.4	1 ~ 1.3	
VPMC40-4R(A)(S)-2J	2						
VPMC40-4R(A)(S)-3J	3		56.7(60.2)				
VPMC40-4R(A)(S)-4J ^⑨	4						
VPMC50-4R(A)(S)-180J	1.8	50	53.9(56.9)	15(18)	8.4	1 ~ 1.3	
VPMC50-4R(A)(S)-2J	2						
VPMC50-4R(A)(S)-3J	3		57.7(60.7)				
VPMC50-4R(A)(S)-4J ^⑨	4						

- ※ .Value in () is the dimension of a deep type pad.
- ※ ^⑤ : Replaced with Pad rubber material code. Refer to page 492 for details.
- ※ ^⑨ : Replaced with "-S3" for -S3 spec. (Copper alloy free material for metal parts and FKM or HNBR for sealing parts). -S3 spec. is available for model codes with ^⑨ in the table above. -S3 spec. is available for Tube O.D. : ø1.8 and ø3mm.
- ※ .Pad material N, NE, and G are not suitable for use under ozone environment.
- ※ .Tightening torque of a pad holder fixing bulkhead nut is as below.
•Pad dia. : ø0.7~ø8mm ▶ 2.5~3.5N·m. •Pad dia. : ø10~ø30mm ▶ 4~6N·m
- ※ .See Pisco website for weight information.



VPMC Spring type / Top port / Barb fitting / Mini holder

VPMC0.7-2RM [5][6][9]

VPMC1-2RM [5][6][9]

VPMC1.5-2RM [5][6][9]

VPMC2-2RM [5][6][9]

VPMC3-2RM [5][6][9]

VPMC4-2RM [5][6][9]

VPMC6-2R [5][6][9]

VPMC8-2R [5][6][9]

VPMC10-4R [5][6][9]

VPMC15-4R(A) [5][6][9]

VPMC20-4R(A) [5][6][9]

VPMC25-4R(A) [5][6][9]

VPMC30-4R(A) [5][6][9]

VPMC40-4R(A) [5][6][9]

VPMC50-4R(A) [5][6][9]

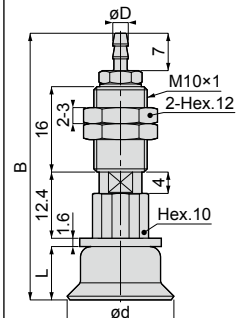
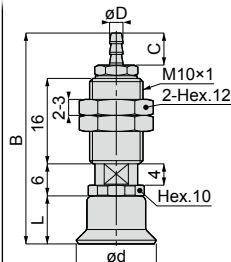
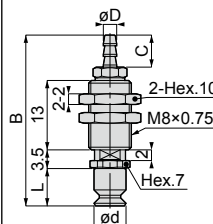
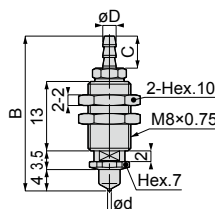

Unit : mm

Model code	Tube I.D. øD	Pad O.D. ød	B	L	C	Spring force (N)	Connection config. code
VPMC0.7-2RM(5-3B)	2	0.7	29.1	—	6	0.2 ~ 0.3	-T4
VPMC0.7-2RM(5-4B)	2.5		30.1				
VPMC0.7-2RM(5-6B)	4		30.1				
VPMC1-2RM(5-3B)	2	1	29.1	—	6	0.2 ~ 0.3	
VPMC1-2RM(5-4B)	2.5		30.1				
VPMC1-2RM(5-6B)	4		30.1				
VPMC1.5-2RM(5-3B)	2	1.5	29.1	—	6	0.2 ~ 0.3	
VPMC1.5-2RM(5-4B)	2.5		30.1				
VPMC1.5-2RM(5-6B)	4		30.1				
VPMC2-2RM(5-3B)	2	2	29.1	—	6	0.2 ~ 0.3	
VPMC2-2RM(5-4B)	2.5		30.1				
VPMC2-2RM(5-6B)	4		30.1				
VPMC3-2RM(5-3B)	2	3	29.1	—	6	0.2 ~ 0.3	
VPMC3-2RM(5-4B)	2.5		30.1				
VPMC3-2RM(5-6B)	4		30.1				
VPMC4-2RM(5-3B)	2	4	29.1	—	6	0.2 ~ 0.3	
VPMC4-2RM(5-4B)	2.5		30.1				
VPMC4-2RM(5-6B)	4		30.1				
VPMC6-2R(5-3B)	2	6	32.1	7	6	0.5 ~ 0.6	-T8
VPMC6-2R(5-4B)	2.5		33.1				
VPMC6-2R(5-6B)	4		33.1				
VPMC8-2R(5-3B)	2	8	30.6	5.5	6	0.5 ~ 0.6	
VPMC8-2R(5-4B)	2.5		31.6				
VPMC8-2R(5-6B)	4		31.6				
VPMC10-4R(5-3B)	2	10	38.6	8	6	1 ~ 1.3	-M4
VPMC10-4R(5-4B)	2.5		40.1				
VPMC10-4R(5-6B)	4		40.1				
VPMC15-4R(A)(5-3B)	2	15	39.6(40.6)	9(10)	6	1 ~ 1.3	
VPMC15-4R(A)(5-4B)	2.5		41.1(42.1)				
VPMC15-4R(A)(5-6B)	4		41.1(42.1)				

Stroke (mm)
2, 4

RoHS Compliant ~~Copper alloy free available~~ CAD (2D&3D)

Unit : mm

Model code	Tube I.D. øD	Pad O.D. ød	B	L	C	Spring force (N)	Connection config. code
VPMC20-4R(A)S-3B9	2	20	48.6(49.6)	10(11)	6	1 ~ 1.3	-M6
VPMC20-4R(A)S-4B9	2.5		50.1(51.1)		7		
VPMC20-4R(A)S-6B9	4						
VPMC25-4R(A)S-3B9	2	25	49.6(50.6)	11(12)	6	1 ~ 1.3	
VPMC25-4R(A)S-4B9	2.5		51.1(52.1)		7		
VPMC25-4R(A)S-6B9	4						
VPMC30-4R(A)S-3B9	2	30	49.6(52.6)	11(14)	6	1 ~ 1.3	
VPMC30-4R(A)S-4B9	2.5		51.1(54.1)		7		
VPMC30-4R(A)S-6B9	4						
VPMC40-4R(A)S-3B9	2	40	52.6(56.1)	14(17.5)	6	1 ~ 1.3	
VPMC40-4R(A)S-4B9	2.5		54.1(57.6)		7		
VPMC40-4R(A)S-6B9	4						
VPMC50-4R(A)S-3B9	2	50	53.6(56.6)	15(18)	6	1 ~ 1.3	
VPMC50-4R(A)S-4B9	2.5		55.1(58.1)		7		
VPMC50-4R(A)S-6B9	4						

※ Value in () is the dimension of a deep type pad.

※ [S] : Replaced with Pad rubber material code. Refer to page 492 for details.

※ [9] : Replaced with "-S3" for -S3 spec. (Copper alloy free material for metal parts and FKM or HNBR for sealing parts).

※ .Pad material N, NE, and G are not suitable for use under ozone environment.

※ .Tightening torque of a pad holder fixing bulkhead nut is as below.

•Pad dia. : ø0.7~ø8mm ▶ 2.5~3.5N·m. •Pad dia. : ø10~ø30mm ▶ 4~6N·m

※ .See Pisco website for weight information.



VPSC Spring type / Top port / Push-in fitting / Slim holder

RoHS Compliant Copper alloy free available CAD (2D&3D)

VPSC1-3R [5][6][9]

VPSC2-3R [5][6][9]

VPSC3-3R [5][6][9]

VPSC4-3R [5][6][9]

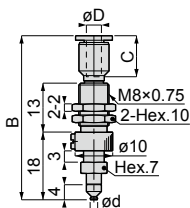

VPSC6-3R [5][6][9]

VPSC8-3R [5][6][9]

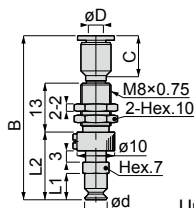

Unit : mm

Stroke (mm)
3

Model code	Tube O.D. øD	Pad O.D. ød	B	L1	L2	Tube end C	Connection config. code
VPSC1-3R[5]-180J	1.8	1	40.7	-	-	8.4	-H3
VPSC1-3R[5]-2J	2		41.7			9.4	
VPSC1-3R[5]-3J	3		43.7			10.9	
VPSC1-3R[5]-4J[9]	4						
VPSC2-3R[5]-180J	1.8	2	40.7	-	-	8.4	
VPSC2-3R[5]-2J	2		41.7			9.4	
VPSC2-3R[5]-3J	3		43.7			10.9	
VPSC2-3R[5]-4J[9]	4						
VPSC3-3R[5]-180J	1.8	3	40.7	-	-	8.4	
VPSC3-3R[5]-2J	2		41.7			9.4	
VPSC3-3R[5]-3J	3		43.7			10.9	
VPSC3-3R[5]-4J[9]	4						
VPSC4-3R[5]-180J	1.8	4	40.7	-	-	8.4	
VPSC4-3R[5]-2J	2		41.7			9.4	
VPSC4-3R[5]-3J	3		43.7			10.9	
VPSC4-3R[5]-4J[9]	4						
VPSC6-3R[5]-180J	1.8	6	40.7	7	18	8.4	-T8
VPSC6-3R[5]-2J	2		41.7			9.4	
VPSC6-3R[5]-3J	3		43.7			10.9	
VPSC6-3R[5]-4J[9]	4						
VPSC8-3R[5]-180J	1.8	8	39.2	5.5	16.5	8.4	
VPSC8-3R[5]-2J	2		40.2			9.4	
VPSC8-3R[5]-3J	3		42.2			10.9	
VPSC8-3R[5]-4J[9]	4						

※ [5] : Replaced with Pad rubber material code. Refer to page 820 for details.

※ [9] : Replaced with "-S3" for -S3 spec. (Copper alloy free material for metal parts and FKM or HNBR for sealing parts). -S3 spec. is available for model codes with [9] in the table above.

※ Pad material N, NE, and G are not suitable for use under ozone environment.

※ Tightening torque of a pad holder fixing bulkhead nut : 1.8~2.4N·m.

※ Spring force : 0.9~1.9N.

※ See Pisco website for weight information.

VPSC Spring type / Top port / Barb fitting / Slim holder



VPSC1-3R [5][6][9]

VPSC2-3R [5][6][9]

VPSC3-3R [5][6][9]

VPSC4-3R [5][6][9]

Stroke (mm)
3

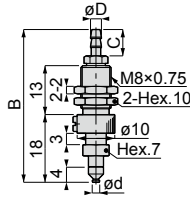

VPSC6-3R [5][6][9]

VPSC8-3R [5][6][9]

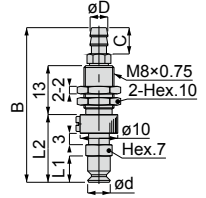

Unit : mm

Model code	Tube I.D. øD	Pad O.D. ød	B	L1	L2	C	Connection config. code
VPSC1-3R [5]-3B [9]	2	1	39.6	-	-	6	-H3
VPSC1-3R [5]-4B [9]	2.5		40.6			7	
VPSC1-3R [5]-6B [9]	4		40.6			7	
VPSC2-3R [5]-3B [9]	2		39.6			6	
VPSC2-3R [5]-4B [9]	2.5	2	40.6	-	-	7	
VPSC2-3R [5]-6B [9]	4		40.6	7			
VPSC3-3R [5]-3B [9]	2	3	39.6	-	-	6	
VPSC3-3R [5]-4B [9]	2.5		40.6			7	
VPSC3-3R [5]-6B [9]	4		40.6			7	
VPSC4-3R [5]-3B [9]	2	4	39.6	-	-	6	
VPSC4-3R [5]-4B [9]	2.5		40.6			7	
VPSC4-3R [5]-6B [9]	4		40.6			7	
VPSC6-3R [5]-3B [9]	2	6	39.6	7	18	6	-T8
VPSC6-3R [5]-4B [9]	2.5		40.6			7	
VPSC6-3R [5]-6B [9]	4		40.6			7	
VPSC8-3R [5]-3B [9]	2	8	38.1	5.5	16.5	6	
VPSC8-3R [5]-4B [9]	2.5		39.1			7	
VPSC8-3R [5]-6B [9]	4		39.1			7	

VPSC Spring type / Top port / Female thread / Slim holder

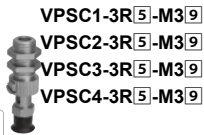

VPSC1-3R [5]-M3 [9]

VPSC2-3R [5]-M3 [9]

VPSC3-3R [5]-M3 [9]

VPSC4-3R [5]-M3 [9]

Stroke (mm)
3

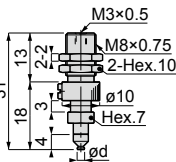

VPSC6-3R [5]-M3 [9]

VPSC8-3R [5]-M3 [9]

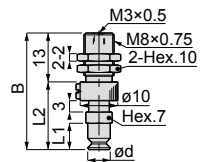

Unit : mm

Model code	Pad O.D. ød	B	L1	L2	Connection config. code
VPSC1-3R [5]-M3 [9]	1	-	-	-	-H3
VPSC2-3R [5]-M3 [9]	2	-	-	-	
VPSC3-3R [5]-M3 [9]	3	-	-	-	
VPSC4-3R [5]-M3 [9]	4	-	-	-	
VPSC6-3R [5]-M3 [9]	6	31	7	18	-T8
VPSC8-3R [5]-M3 [9]	8	29.5	5.5	16.5	

※ [5] : Replaced with Pad rubber material code. Refer to page 820 for details.

※ [9] : Replaced with "-S3" for -S3 spec. (Copper alloy free material for metal parts and FKM or HNBR for sealing parts).

※ Pad material N, NE, and G are not suitable for use under ozone environment.

※ Tightening torque of a pad holder fixing bulkhead nut : 1.8~2.4N·m.

※ Spring force : 0.9~1.9N.

※ See Pisco website for weight information.



VPC Spring type / Top port / Push-in fitting / Standard holder

Unit : mm

VPC1[R][S][6][9]

VPC2[R][S][6][9]

Connection
config. code
-H3

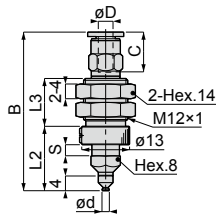

Stroke (mm)
3, 10, 15, 20

Model code	Tube O.D. øD	Pad O.D. ød	B	L2	L3	Tube end C	Stroke S	Spring force (N)
VPC1-3R[5]-180J	1.8	1	39.4	17.5	13	8.4	3	0.9~1.9
VPC1-10R[5]-180J			53.4	27	17.5		10	0.6~1.7
VPC1-15R[5]-180J			64.4	32	23.5		15	0.4~1.7
VPC1-20R[5]-180J	2	1	74.4	37	28.5	8.4	20	0.3~1.8
VPC1-3R[5]-2J			39.4	17.5	13		3	0.9~1.9
VPC1-10R[5]-2J			53.4	27	17.5		10	0.6~1.7
VPC1-15R[5]-2J	3	1	64.4	32	23.5	10.9	15	0.4~1.7
VPC1-20R[5]-2J			74.4	37	28.5		20	0.3~1.8
VPC1-3R[5]-3J			43.2	17.5	13		3	0.9~1.9
VPC1-10R[5]-3J	4	1	57.2	27	17.5	10.9	10	0.6~1.7
VPC1-15R[5]-3J			68.2	32	23.5		15	0.4~1.7
VPC1-20R[5]-3J			78.2	37	28.5		20	0.3~1.8
VPC1-3R[5]-4J[9]	4	1	43.2	17.5	13	10.9	3	0.9~1.9
VPC1-10R[5]-4J			57.2	27	17.5		10	0.6~1.7
VPC1-15R[5]-4J			68.2	32	23.5		15	0.4~1.7
VPC1-20R[5]-4J	6	1	78.2	37	28.5	11.7	20	0.3~1.8
VPC1-3R[5]-6J[9]			45.1	17.5	13		3	0.9~1.9
VPC1-10R[5]-6J			59.1	27	17.5		10	0.6~1.7
VPC1-15R[5]-6J	1.8	2	70.1	32	23.5	8.4	15	0.4~1.7
VPC1-20R[5]-6J			80.1	37	28.5		20	0.3~1.8
VPC2-3R[5]-180J			39.4	17.5	13		3	0.9~1.9
VPC2-10R[5]-180J	2	2	53.4	27	17.5	8.4	10	0.6~1.7
VPC2-15R[5]-180J			64.4	32	23.5		15	0.4~1.7
VPC2-20R[5]-180J			74.4	37	28.5		20	0.3~1.8
VPC2-3R[5]-2J	3	2	39.4	17.5	13	8.4	3	0.9~1.9
VPC2-10R[5]-2J			53.4	27	17.5		10	0.6~1.7
VPC2-15R[5]-2J			64.4	32	23.5		15	0.4~1.7
VPC2-20R[5]-2J	4	2	74.4	37	28.5	10.9	20	0.3~1.8
VPC2-3R[5]-3J			43.2	17.5	13		3	0.9~1.9
VPC2-10R[5]-3J			57.2	27	17.5		10	0.6~1.7
VPC2-15R[5]-3J	4	2	68.2	32	23.5	10.9	15	0.4~1.7
VPC2-20R[5]-3J			78.2	37	28.5		20	0.3~1.8
VPC2-3R[5]-4J[9]			43.2	17.5	13		3	0.9~1.9
VPC2-10R[5]-4J	6	2	57.2	27	17.5	11.7	10	0.6~1.7
VPC2-15R[5]-4J			68.2	32	23.5		15	0.4~1.7
VPC2-20R[5]-4J			78.2	37	28.5		20	0.3~1.8
VPC2-3R[5]-6J[9]	1.8	2	45.1	17.5	13	8.4	3	0.9~1.9
VPC2-10R[5]-6J			59.1	27	17.5		10	0.6~1.7
VPC2-15R[5]-6J			70.1	32	23.5		15	0.4~1.7
VPC2-20R[5]-6J	2	2	80.1	37	28.5	11.7	20	0.3~1.8
VPC2-3R[5]-3J			43.2	17.5	13		3	0.9~1.9
VPC2-10R[5]-3J			57.2	27	17.5		10	0.6~1.7
VPC2-15R[5]-3J	4	2	68.2	32	23.5	10.9	15	0.4~1.7
VPC2-20R[5]-3J			78.2	37	28.5		20	0.3~1.8
VPC2-3R[5]-4J[9]			43.2	17.5	13		3	0.9~1.9
VPC2-10R[5]-4J	6	2	57.2	27	17.5	11.7	10	0.6~1.7
VPC2-15R[5]-4J			68.2	32	23.5		15	0.4~1.7
VPC2-20R[5]-4J			78.2	37	28.5		20	0.3~1.8
VPC2-3R[5]-6J[9]	1.8	2	45.1	17.5	13	8.4	3	0.9~1.9
VPC2-10R[5]-6J			59.1	27	17.5		10	0.6~1.7
VPC2-15R[5]-6J			70.1	32	23.5		15	0.4~1.7
VPC2-20R[5]-6J	2	2	80.1	37	28.5	11.7	20	0.3~1.8

RoHS Compliant

Copper alloy free available

CAD (2D&3D)

※ [5] : Replaced with Pad rubber material code. Refer to page 492 for details.

※ [9] : Replaced with "-S3" for -S3 spec. (Copper alloy free material for metal parts and FKM or HNBR for sealing parts). -S3 spec. is available for model codes with [9] in the table above.

※ Pad material N, NE, and G are not suitable for use under ozone environment.

※ Tightening torque of a pad holder fixing bulkhead nut is as below.

•Pad dia. : ø1~ø8mm ▶ 8~10N·m

※ See Pisco website for weight information.

Unit : mm

VPC3[3R][5][6][9]
VPC4[3R][5][6][9]

Connection
config. code
-H3

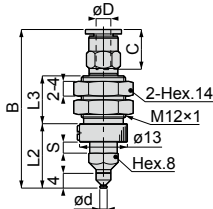

Stroke (mm)
3, 10, 15, 20

Model code	Tube O.D. øD	Pad O.D. ød	B	L2	L3	Tube end C	Stroke S	Spring force (N)
VPC3-3R[5]-180J	1.8	3	39.4	17.5	13	8.4	3	0.9~1.9
VPC3-10R[5]-180J			53.4	27	17.5		10	0.6~1.7
VPC3-15R[5]-180J			64.4	32	23.5		15	0.4~1.7
VPC3-20R[5]-180J	74.4		37	28.5	20	0.3~1.8		
VPC3-3R[5]-2J	2		39.4	17.5	13	8.4	3	0.9~1.9
VPC3-10R[5]-2J			53.4	27	17.5		10	0.6~1.7
VPC3-15R[5]-2J			64.4	32	23.5		15	0.4~1.7
VPC3-20R[5]-2J	74.4		37	28.5	20	0.3~1.8		
VPC3-3R[5]-3J	3		43.2	17.5	13	10.9	3	0.9~1.9
VPC3-10R[5]-3J			57.2	27	17.5		10	0.6~1.7
VPC3-15R[5]-3J			68.2	32	23.5		15	0.4~1.7
VPC3-20R[5]-3J	78.2		37	28.5	20	0.3~1.8		
VPC3-3R[5]-4J[9]	4		43.2	17.5	13	10.9	3	0.9~1.9
VPC3-10R[5]-4J			57.2	27	17.5		10	0.6~1.7
VPC3-15R[5]-4J			68.2	32	23.5		15	0.4~1.7
VPC3-20R[5]-4J	78.2	37	28.5	20	0.3~1.8			
VPC3-3R[5]-6J[9]	6	45.1	17.5	13	11.7	3	0.9~1.9	
VPC3-10R[5]-6J		59.1	27	17.5		10	0.6~1.7	
VPC3-15R[5]-6J		70.1	32	23.5		15	0.4~1.7	
VPC3-20R[5]-6J	80.1	37	28.5	20	0.3~1.8			
VPC4-3R[5]-180J	1.8	4	39.4	17.5	13	8.4	3	0.9~1.9
VPC4-10R[5]-180J			53.4	27	17.5		10	0.6~1.7
VPC4-15R[5]-180J			64.4	32	23.5		15	0.4~1.7
VPC4-20R[5]-180J	74.4		37	28.5	20	0.3~1.8		
VPC4-3R[5]-2J	2		39.4	17.5	13	8.4	3	0.9~1.9
VPC4-10R[5]-2J			53.4	27	17.5		10	0.6~1.7
VPC4-15R[5]-2J			64.4	32	23.5		15	0.4~1.7
VPC4-20R[5]-2J	74.4		37	28.5	20	0.3~1.8		
VPC4-3R[5]-3J	3		43.2	17.5	13	10.9	3	0.9~1.9
VPC4-10R[5]-3J			57.2	27	17.5		10	0.6~1.7
VPC4-15R[5]-3J			68.2	32	23.5		15	0.4~1.7
VPC4-20R[5]-3J	78.2		37	28.5	20	0.3~1.8		
VPC4-3R[5]-4J[9]	4		43.2	17.5	13	10.9	3	0.9~1.9
VPC4-10R[5]-4J			57.2	27	17.5		10	0.6~1.7
VPC4-15R[5]-4J			68.2	32	23.5		15	0.4~1.7
VPC4-20R[5]-4J	78.2	37	28.5	20	0.3~1.8			
VPC4-3R[5]-6J[9]	6	45.1	17.5	13	11.7	3	0.9~1.9	
VPC4-10R[5]-6J		59.1	27	17.5		10	0.6~1.7	
VPC4-15R[5]-6J		70.1	32	23.5		15	0.4~1.7	
VPC4-20R[5]-6J	80.1	37	28.5	20	0.3~1.8			

RoHS Compliant

Copper alloy free available

CAD (2D&3D)

526

- ※ [5] : Replaced with Pad rubber material code. Refer to page 492 for details.
- ※ [9] : Replaced with "-S3" for -S3 spec. (Copper alloy free material for metal parts and FKM or HNBR for sealing parts). -S3 spec. is available for model codes with [9] in the table above.
- ※ Pad material N, NE, and G are not suitable for use under ozone environment.
- ※ Tightening torque of a pad holder fixing bulkhead nut is as below.
•Pad dia. : ø1~ø8mm ▶ 8~10N·m
- ※ See Pisco website for weight information.



Unit : mm

VPC6 3 R 5 6 9
 VPC8 3 R 5 6 9

Connection
config. code
-T8

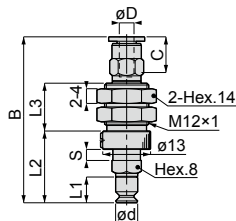

Stroke (mm)
3, 10, 15, 20

Model code	Tube O.D. øD	Pad O.D. ød	B	L1	L2	L3	Tube end C	Stroke S	Spring force (N)
VPC6-3R 5 -180J	1.8		41.4	7	19.5	13	8.4	3	0.9~1.9
VPC6-10R 5 -180J			52.9		26.5	17.5		10	0.8~2.7
VPC6-15R 5 -180J			63.9		31.5	23.5		15	0.7~3.0
VPC6-20R 5 -180J			73.9		36.5	28.5		20	0.9~3.4
VPC6-3R 5 -2J	2		41.4	7	19.5	13	8.4	3	0.9~1.9
VPC6-10R 5 -2J			52.9		26.5	17.5		10	0.8~2.7
VPC6-15R 5 -2J			63.9		31.5	23.5		15	0.7~3.0
VPC6-20R 5 -2J			73.9		36.5	28.5		20	0.9~3.4
VPC6-3R 5 -3J	3	6	45.2	7	19.5	13	10.9	3	0.9~1.9
VPC6-10R 5 -3J			56.7		26.5	17.5		10	0.8~2.7
VPC6-15R 5 -3J			67.7		31.5	23.5		15	0.7~3.0
VPC6-20R 5 -3J			77.7		36.5	28.5		20	0.9~3.4
VPC6-3R 5 -4J 9	4		45.2	7	19.5	13	10.9	3	0.9~1.9
VPC6-10R 5 -4J			56.7		26.5	17.5		10	0.8~2.7
VPC6-15R 5 -4J			67.7		31.5	23.5		15	0.7~3.0
VPC6-20R 5 -4J			77.7		36.5	28.5		20	0.9~3.4
VPC6-3R 5 -6J 9	6		47.1	7	19.5	13	11.7	3	0.9~1.9
VPC6-10R 5 -6J			58.6		26.5	17.5		10	0.8~2.7
VPC6-15R 5 -6J			69.6		31.5	23.5		15	0.7~3.0
VPC6-20R 5 -6J			79.6		36.5	28.5		20	0.9~3.4
VPC8-3R 5 -180J	1.8		39.9	5.5	18	13	8.4	3	0.9~1.9
VPC8-10R 5 -180J			51.4		25	17.5		10	0.8~2.7
VPC8-15R 5 -180J			62.4		30	23.5		15	0.7~3.0
VPC8-20R 5 -180J			72.4		35	28.5		20	0.9~3.4
VPC8-3R 5 -2J	2		39.9	5.5	18	13	8.4	3	0.9~1.9
VPC8-10R 5 -2J			51.4		25	17.5		10	0.8~2.7
VPC8-15R 5 -2J			62.4		30	23.5		15	0.7~3.0
VPC8-20R 5 -2J			72.4		35	28.5		20	0.9~3.4
VPC8-3R 5 -3J	3	8	43.7	5.5	18	13	10.9	3	0.9~1.9
VPC8-10R 5 -3J			55.2		25	17.5		10	0.8~2.7
VPC8-15R 5 -3J			66.2		30	23.5		15	0.7~3.0
VPC8-20R 5 -3J			76.2		35	28.5		20	0.9~3.4
VPC8-3R 5 -4J 9	4		43.7	5.5	18	13	10.9	3	0.9~1.9
VPC8-10R 5 -4J			55.2		25	17.5		10	0.8~2.7
VPC8-15R 5 -4J			66.2		30	23.5		15	0.7~3.0
VPC8-20R 5 -4J			76.2		35	28.5		20	0.9~3.4
VPC8-3R 5 -6J 9	6		45.6	5.5	18	13	11.7	3	0.9~1.9
VPC8-10R 5 -6J			57.1		25	17.5		10	0.8~2.7
VPC8-15R 5 -6J			68.1		30	23.5		15	0.7~3.0
VPC8-20R 5 -6J			78.1		35	28.5		20	0.9~3.4

RoHS Compliant

Copper alloy free available

CAD (2D&3D)

※ 5 : Replaced with Pad rubber material code. Refer to page 492 for details.

※ 9 : Replaced with "-S3" for -S3 spec. (Copper alloy free material for metal parts and FKM or HNBR for sealing parts). -S3 spec. is available for model codes with 9 in the table above.

※ Pad material N, NE, and G are not suitable for use under ozone environment.

※ Tightening torque of a pad holder fixing bulkhead nut is as below.

• Pad dia. : ø1~ø8mm ▶ 8~10N·m

※ See Pisco website for weight information.

Unit : mm

VPC10 3 R 5 6 9
VPC15 3 R(A) 5 6 9

Connection
config. code
-M4

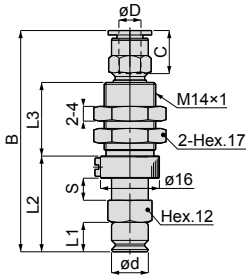

Stroke (mm)
6, 10, 15, 20

RoHS Compliant

Copper alloy free available

CAD (2D&3D)

Model code	Tube O.D. øD	Pad O.D. ød	B	L1	L2	L3	Tube end C	Stroke S	Spring force (N)
VPC10-6R 5 -3J	3	10	58.7	8	26	20	10.9	6	4.0~7.1
VPC10-10R 5 -3J			63.2		30.5			10	2.0~5.2
VPC10-15R 5 -3J			73.2		35.5			25	15
VPC10-20R 5 -3J	89.2		42.5		34	20	1.1~4.8		
VPC10-6R 5 -4J 9	4		58.7		26	20	10.9	6	4.0~7.1
VPC10-10R 5 -4J			63.2		30.5			10	2.0~5.2
VPC10-15R 5 -4J		73.2	35.5	25	15			2.0~5.9	
VPC10-20R 5 -4J	6	89.2	42.5	34	11.7	20	1.1~4.8		
VPC10-6R 5 -6J 9		60.1	26	6		4.0~7.1			
VPC10-10R 5 -6J		64.6	30.5	10		2.0~5.2			
VPC10-15R 5 -6J	6	74.6	35.5	25	11.7	15	2.0~5.9		
VPC10-20R 5 -6J		90.6	42.5	34		20	1.1~4.8		
VPC15-6R(A) 5 -3J		3	15	59.7(60.7)		9(10)	27(28)	20	10.9
VPC15-10R(A) 5 -3J	64.2(65.2)			31.5(32.5)	10		2.0~5.2		
VPC15-15R(A) 5 -3J	74.2(75.2)			36.5(37.5)	25		15		
VPC15-20R(A) 5 -3J	90.2(91.2)	43.5(44.5)		34	20		1.1~4.8		
VPC15-6R(A) 5 -4J 9	4	59.7(60.7)		27(28)	20		10.9	6	4.0~7.1
VPC15-10R(A) 5 -4J		64.2(65.2)		31.5(32.5)				10	2.0~5.2
VPC15-15R(A) 5 -4J		74.2(75.2)	36.5(37.5)	25		15		2.0~5.9	
VPC15-20R(A) 5 -4J	6	90.2(91.2)	43.5(44.5)	34	11.7	20	1.1~4.8		
VPC15-6R(A) 5 -6J 9		61.1(62.1)	27(28)	6		4.0~7.1			
VPC15-10R(A) 5 -6J		65.6(66.6)	31.5(32.5)	10		2.0~5.2			
VPC15-15R(A) 5 -6J	6	75.6(76.6)	36.5(37.5)	25	11.7	15	2.0~5.9		
VPC15-20R(A) 5 -6J		91.6(92.6)	43.5(44.5)	34		20	1.1~4.8		

※ . Value in () is the dimension of a deep type pad.

※ 5 : Replaced with Pad rubber material code. Refer to page 492 for details.

※ 9 : Replaced with "-S3" for -S3 spec. (Copper alloy free material for metal parts and FKM or HNBR for sealing parts). -S3 spec. is available for model codes with 9 in the table above.

※ . Pad material N, NE, and G are not suitable for use under ozone environment.

※ . Tightening torque of a pad holder fixing bulkhead nut is as below.

• Pad dia. : ø10~ø50mm ▶ 4.5~6N·m

※ . See Pisco website for weight information.



VPC20 3R(A) 5 6 9
 VPC25 3R(A) 5 6 9
 VPC30 3R(A) 5 6 9
 VPC40 3R(A) 5 6 9
 VPC50 3R(A) 5 6 9

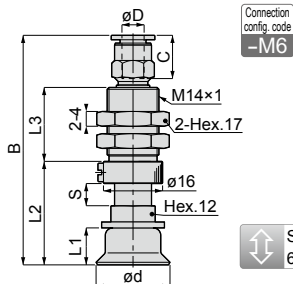

Connection
 config. code
 -M6

- RoHS Compliant
- Copper alloy free available
- CAD (2D&3D)

Stroke (mm)
 6, 10, 15, 20

Unit : mm

Model code	Tube O.D. øD	Pad O.D. ød	B	L1	L2	L3	Tube end C	Stroke S	Spring force (N)	
VPC20-6R(A) 5-3J	3	20	60.7(61.7)	10(11)	28(29)	20	10.9	6	7.0 ~ 12.6	
VPC20-10R(A) 5-3J			66.7(67.7)		34(35)			10	3.3 ~ 10.0	
VPC20-15R(A) 5-3J			76.7(77.7)		39(40)			25	15	3.3 ~ 10.4
VPC20-20R(A) 5-3J			92.7(93.7)		46(47)			34	20	2.0 ~ 8.7
VPC20-6R(A) 5-4J 9	4		60.7(61.7)		28(29)	20	10.9	6	7.0 ~ 12.6	
VPC20-10R(A) 5-4J			66.7(67.7)		34(35)			10	3.3 ~ 10.0	
VPC20-15R(A) 5-4J			76.7(77.7)		39(40)			25	15	3.3 ~ 10.4
VPC20-20R(A) 5-4J			92.7(93.7)		46(47)			34	20	2.0 ~ 8.7
VPC20-6R(A) 5-6J 9	6		62.1(63.1)		28(29)	20	11.7	6	7.0 ~ 12.6	
VPC20-10R(A) 5-6J			68.1(69.1)		34(35)			10	3.3 ~ 10.0	
VPC20-15R(A) 5-6J			78.1(79.1)		39(40)			25	15	3.3 ~ 10.4
VPC20-20R(A) 5-6J			94.1(95.1)		46(47)			34	20	2.0 ~ 8.7
VPC25-6R(A) 5-3J	3	25	61.7(62.7)	11(12)	29(30)	20	10.9	6	7.0 ~ 12.6	
VPC25-10R(A) 5-3J			67.7(68.7)		35(36)			10	3.3 ~ 10.0	
VPC25-15R(A) 5-3J			77.7(78.7)		40(41)			25	15	3.3 ~ 10.4
VPC25-20R(A) 5-3J			93.7(94.7)		47(48)			34	20	2.0 ~ 8.7
VPC25-6R(A) 5-4J 9	4		61.7(62.7)		29(30)	20	10.9	6	7.0 ~ 12.6	
VPC25-10R(A) 5-4J			67.7(68.7)		35(36)			10	3.3 ~ 10.0	
VPC25-15R(A) 5-4J			77.7(78.7)		40(41)			25	15	3.3 ~ 10.4
VPC25-20R(A) 5-4J			93.7(94.7)		47(48)			34	20	2.0 ~ 8.7
VPC25-6R(A) 5-6J 9	6		63.1(64.1)		29(30)	20	11.7	6	7.0 ~ 12.6	
VPC25-10R(A) 5-6J			69.1(70.1)		35(36)			10	3.3 ~ 10.0	
VPC25-15R(A) 5-6J			79.1(80.1)		40(41)			25	15	3.3 ~ 10.4
VPC25-20R(A) 5-6J			95.1(96.1)		47(48)			34	20	2.0 ~ 8.7

- ※ Value in () is the dimension of a deep type pad.
- ※ [5] : Replaced with Pad rubber material code. Refer to page 492 for details.
- ※ [9] : Replaced with "-S3" for -S3 spec. (Copper alloy free material for metal parts and FKM or HNBR for sealing parts). -S3 spec. is available for model codes with [9] in the table above.
- ※ Pad material N, NE, and G are not suitable for use under ozone environment.
- ※ Tightening torque of a pad holder fixing bulkhead nut is as below.
 - Pad dia. : ø10-ø50mm ▶ 4.5-6N·m
- ※ See Pisco website for weight information.

Unit : mm

Model code	Tube O.D. øD	Pad O.D. ød	B	L1	L2	L3	Tube end C	Stroke S	Spring force (N)				
VPC30-6R(A)S-3J	3	30	61.7(64.7)	11(14)	29(32)	20	10.9	6	7.0 ~ 12.6				
VPC30-10R(A)S-3J			67.7(70.7)		35(38)			10	3.3 ~ 10.0				
VPC30-15R(A)S-3J			77.7(80.7)		40(43)	25		15	3.3 ~ 10.4				
VPC30-20R(A)S-3J			93.7(96.7)		47(50)	34		20	2.0 ~ 8.7				
VPC30-6R(A)S-4J	4		30		61.7(64.7)	11(14)	29(32)	20	10.9	6	7.0 ~ 12.6		
VPC30-10R(A)S-4J					67.7(70.7)		35(38)			10	3.3 ~ 10.0		
VPC30-15R(A)S-4J					77.7(80.7)		40(43)	25		15	3.3 ~ 10.4		
VPC30-20R(A)S-4J					93.7(96.7)		47(50)	34		20	2.0 ~ 8.7		
VPC30-6R(A)S-6J	6				30		63.1(66.1)	11(14)	29(32)	20	11.7	6	7.0 ~ 12.6
VPC30-10R(A)S-6J							69.1(72.1)		35(38)			10	3.3 ~ 10.0
VPC30-15R(A)S-6J							79.1(82.1)		40(43)	25		15	3.3 ~ 10.4
VPC30-20R(A)S-6J							95.1(98.1)		47(50)	34		20	2.0 ~ 8.7
VPC40-6R(A)S-3J	3	40		64.7(68.2)			14(17.5)		32(35.5)	20	10.9	6	7.0 ~ 12.6
VPC40-10R(A)S-3J				70.7(74.2)					38(41.5)			10	3.3 ~ 10.0
VPC40-15R(A)S-3J				80.7(84.2)					43(46.5)	25		15	3.3 ~ 10.4
VPC40-20R(A)S-3J				96.7(100.2)					50(53.5)	34		20	2.0 ~ 8.7
VPC40-6R(A)S-4J	4		40	64.7(68.2)		14(17.5)			32(35.5)	20	10.9	6	7.0 ~ 12.6
VPC40-10R(A)S-4J				70.7(74.2)					38(41.5)			10	3.3 ~ 10.0
VPC40-15R(A)S-4J				80.7(84.2)					43(46.5)	25		15	3.3 ~ 10.4
VPC40-20R(A)S-4J				96.7(100.2)					50(53.5)	34		20	2.0 ~ 8.7
VPC40-6R(A)S-6J	6			40	66.1(69.6)			14(17.5)	32(35.5)	20	11.7	6	7.0 ~ 12.6
VPC40-10R(A)S-6J					72.1(75.6)				38(41.5)			10	3.3 ~ 10.0
VPC40-15R(A)S-6J					82.1(85.6)				43(46.5)	25		15	3.3 ~ 10.4
VPC40-20R(A)S-6J					98.1(101.6)				50(53.5)	34		20	2.0 ~ 8.7
VPC50-6R(A)S-3J	3	50			65.7(68.7)		15(18)		33(36)	20	10.9	6	7.0 ~ 12.6
VPC50-10R(A)S-3J					71.7(74.7)				39(42)			10	3.3 ~ 10.0
VPC50-15R(A)S-3J					81.7(84.7)				44(47)	25		15	3.3 ~ 10.4
VPC50-20R(A)S-3J					97.7(100.7)				51(54)	34		20	2.0 ~ 8.7
VPC50-6R(A)S-4J	4		50		65.7(68.7)	15(18)			33(36)	20	10.9	6	7.0 ~ 12.6
VPC50-10R(A)S-4J					71.7(74.7)				39(42)			10	3.3 ~ 10.0
VPC50-15R(A)S-4J					81.7(84.7)				44(47)	25		15	3.3 ~ 10.4
VPC50-20R(A)S-4J					97.7(100.7)				51(54)	34		20	2.0 ~ 8.7
VPC50-6R(A)S-6J	6			50	67.1(70.1)			15(18)	33(36)	20	11.7	6	7.0 ~ 12.6
VPC50-10R(A)S-6J					73.1(76.1)				39(42)			10	3.3 ~ 10.0
VPC50-15R(A)S-6J					83.1(86.1)				44(47)	25		15	3.3 ~ 10.4
VPC50-20R(A)S-6J					99.1(102.1)				51(54)	34		20	2.0 ~ 8.7

※ .Value in () is the dimension of a deep type pad.

※ [S] : Replaced with Pad rubber material code. Refer to page 492 for details.

※ [J] : Replaced with "-S3" for -S3 spec. (Copper alloy free material for metal parts and FKM or HNBR for sealing parts). -S3 spec. is available for model codes with [J] in the table above.

※ .Pad material N, NE, and G are not suitable for use under ozone environment.

※ .Tightening torque of a pad holder fixing bulkhead nut is as below.

•Pad dia. : ø10~ø50mm ▶ 4.5~6N·m

※ .See Pisco website for weight information.



VPC60-10R(A) [5] [6]
 VPC80-10R(A) [5] [6]
 VPC100-10R(A) [5] [6]
 VPC150-20R [5] [6]
 VPC200-20R [5] [6]

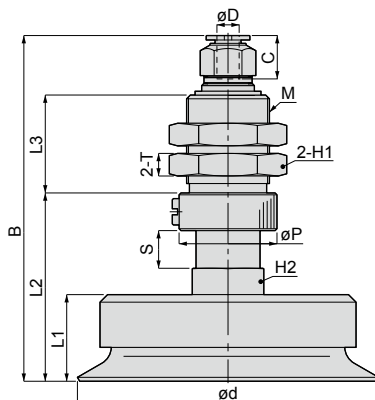

Connection
config. code
-M10

Connection
config. code
-M20

- RoHS Compliant
- Copper alloy free available
- CAD (2D&3D)

Stroke (mm)
6, 10, 15, 20

Unit : mm

Model code	Tube O.D. øD	Pad O.D. ød	Thread M	B	L1	L2	L3	øP	Tube end C	Hex. H1	Hex. H2	T	Stroke S	Spring force (N)
VPC60-10R(A) [5]-4J	4	60	M22×1	87.3(94.3)	18(25)	47.6(54.6)	26	26	10.9	27	19	6	10	10.1~15.8
VPC60-10R(A) [5]-6J	6			11.7										
VPC60-10R(A) [5]-8J	8			18.2										
VPC80-10R(A) [5]-4J	4	80	M22×1	89.7(99.7)	23(33)	50(60)	26	26	10.9	27	19	6	10	10.1~15.8
VPC80-10R(A) [5]-6J	6			11.7										
VPC80-10R(A) [5]-8J	8			18.2										
VPC100-10R(A) [5]-4J	4	100	M22×1	91.7(100.7)	25(34)	52(61)	26	26	10.9	27	19	6	10	10.1~15.8
VPC100-10R(A) [5]-6J	6			11.7										
VPC100-10R(A) [5]-8J	8			18.2										
VPC150-20R [5]-6J	6	150	M30×2	180.4	45	112.1	48	35	17	36	30	10	20.1	14.0~25.5
VPC150-20R [5]-8J	8			18.2										
VPC150-20R [5]-10J	10			20.7										
VPC150-20R [5]-12J	12			193.3					23.3					
VPC200-20R [5]-6J	6	200	M30×2	185.4	50	117.1	48	35	17	36	30	10	20.1	14.0~25.5
VPC200-20R [5]-8J	8			18.2										
VPC200-20R [5]-10J	10			20.7										
VPC200-20R [5]-12J	12			23.3										

- ※ .Value in () is the dimension of a deep type pad.
- ※ [5] : Replaced with Pad rubber material code. Refer to page 492 for details.
- ※ .Pad material N, NE, and G are not suitable for use under ozone environment.
- ※ .Tightening torque of a pad holder fixing bulkhead nut is as below.
 - Pad dia. : ø60~ø100mm ▶ 16~20N·m. •Pad dia. : ø150~ø200mm ▶ 42~54N·m
- ※ .See Pisco website for weight information.

VPC Spring type / Top port / Barb fitting / Standard holder

Unit : mm

VPC1 3R 5 6 9
VPC2 3R 5 6 9
VPC3 3R 5 6 9
VPC4 3R 5 6 9

Connection
config. code
-H3

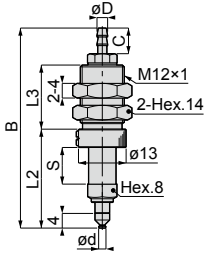

Stroke (mm)
3, 10, 15, 20

Model code	Tube I.D. øD	Pad O.D. ød	B	L2	L3	Tube end C	Stroke S	Spring force (N)
VPC1-3R 5-3B 9	2	1	39.1	17.5	13	6	3	0.9~1.9
VPC1-10R 5-3B			53.1	27	17.5		10	0.6~1.7
VPC1-15R 5-3B			64.1	32	23.5		15	0.4~1.7
VPC1-20R 5-3B			74.1	37	28.5		20	0.3~1.8
VPC1-3R 5-4B 9	2.5	1	40.6	17.5	13	7	3	0.9~1.9
VPC1-10R 5-4B			54.6	27	17.5		10	0.6~1.7
VPC1-15R 5-4B			65.6	32	23.5		15	0.4~1.7
VPC1-20R 5-4B			75.6	37	28.5		20	0.3~1.8
VPC1-3R 5-6B 9	4	1	40.6	17.5	13	7	3	0.9~1.9
VPC1-10R 5-6B			54.6	27	17.5		10	0.6~1.7
VPC1-15R 5-6B			65.6	32	23.5		15	0.4~1.7
VPC1-20R 5-6B			75.6	37	28.5		20	0.3~1.8
VPC2-3R 5-3B 9	2	2	39.1	17.5	13	6	3	0.9~1.9
VPC2-10R 5-3B			53.1	27	17.5		10	0.6~1.7
VPC2-15R 5-3B			64.1	32	23.5		15	0.4~1.7
VPC2-20R 5-3B			74.1	37	28.5		20	0.3~1.8
VPC2-3R 5-4B 9	2.5	2	40.6	17.5	13	7	3	0.9~1.9
VPC2-10R 5-4B			54.6	27	17.5		10	0.6~1.7
VPC2-15R 5-4B			65.6	32	23.5		15	0.4~1.7
VPC2-20R 5-4B			75.6	37	28.5		20	0.3~1.8
VPC2-3R 5-6B 9	4	2	40.6	17.5	13	7	3	0.9~1.9
VPC2-10R 5-6B			54.6	27	17.5		10	0.6~1.7
VPC2-15R 5-6B			65.6	32	23.5		15	0.4~1.7
VPC2-20R 5-6B			75.6	37	28.5		20	0.3~1.8
VPC3-3R 5-3B 9	2	3	39.1	17.5	13	6	3	0.9~1.9
VPC3-10R 5-3B			53.1	27	17.5		10	0.6~1.7
VPC3-15R 5-3B			64.1	32	23.5		15	0.4~1.7
VPC3-20R 5-3B			74.1	37	28.5		20	0.3~1.8
VPC3-3R 5-4B 9	2.5	3	40.6	17.5	13	7	3	0.9~1.9
VPC3-10R 5-4B			54.6	27	17.5		10	0.6~1.7
VPC3-15R 5-4B			65.6	32	23.5		15	0.4~1.7
VPC3-20R 5-4B			75.6	37	28.5		20	0.3~1.8
VPC3-3R 5-6B 9	4	3	40.6	17.5	13	7	3	0.9~1.9
VPC3-10R 5-6B			54.6	27	17.5		10	0.6~1.7
VPC3-15R 5-6B			65.6	32	23.5		15	0.4~1.7
VPC3-20R 5-6B			75.6	37	28.5		20	0.3~1.8
VPC4-3R 5-3B 9	2	4	39.1	17.5	13	6	3	0.9~1.9
VPC4-10R 5-3B			53.1	27	17.5		10	0.6~1.7
VPC4-15R 5-3B			64.1	32	23.5		15	0.4~1.7
VPC4-20R 5-3B			74.1	37	28.5		20	0.3~1.8
VPC4-3R 5-4B 9	2.5	4	40.6	17.5	13	7	3	0.9~1.9
VPC4-10R 5-4B			54.6	27	17.5		10	0.6~1.7
VPC4-15R 5-4B			65.6	32	23.5		15	0.4~1.7
VPC4-20R 5-4B			75.6	37	28.5		20	0.3~1.8
VPC4-3R 5-6B 9	4	4	40.6	17.5	13	7	3	0.9~1.9
VPC4-10R 5-6B			54.6	27	17.5		10	0.6~1.7
VPC4-15R 5-6B			65.6	32	23.5		15	0.4~1.7
VPC4-20R 5-6B			75.6	37	28.5		20	0.3~1.8

- RoHS Compliant
- Copper alloy free available
- CAD (2D&3D)



Unit : mm

VPC6[3]R[5][6][9]

VPC8[3]R[5][6][9]

Connection
config. code
-T8

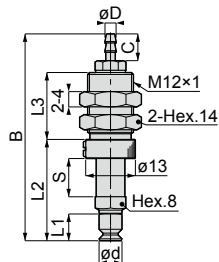

VPC10[3]R[5][6][9]

VPC15[3]R(A)[5][6][9]

Connection
config. code
-M4

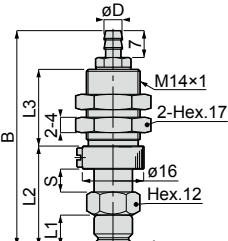

Stroke (mm)
3,6,10,15,20

Model code	Tube I.D. øD	Pad O.D. ød	B	L1	L2	L3	C	Stroke S	Spring force (N)
VPC6-3R[5]-3B[9]	2	6	41.1	7	19.5	13	6	3	0.9~1.9
VPC6-10R[5]-3B			52.6		26.5	17.5		10	0.8~2.7
VPC6-15R[5]-3B			63.6		31.5	23.5		15	0.7~3.0
VPC6-20R[5]-3B	2.5	6	73.6	7	36.5	28.5	7	20	0.9~3.4
VPC6-3R[5]-4B[9]			42.6		19.5	13		3	0.9~1.9
VPC6-10R[5]-4B			54.1		26.5	17.5		10	0.8~2.7
VPC6-15R[5]-4B	4	6	65.1	7	31.5	23.5	7	15	0.7~3.0
VPC6-20R[5]-4B			75.1		36.5	28.5		20	0.9~3.4
VPC6-3R[5]-6B[9]			42.6		19.5	13		3	0.9~1.9
VPC6-10R[5]-6B	2	8	54.1	5.5	26.5	17.5	6	10	0.8~2.7
VPC6-15R[5]-6B			65.1		31.5	23.5		15	0.7~3.0
VPC6-20R[5]-6B			75.1		36.5	28.5		20	0.9~3.4
VPC8-3R[5]-3B[9]	2.5	8	39.6	5.5	18	13	7	3	0.9~1.9
VPC8-10R[5]-3B			51.1		25	17.5		10	0.8~2.7
VPC8-15R[5]-3B			62.1		30	23.5		15	0.7~3.0
VPC8-20R[5]-3B	4	8	72.1	5.5	35	28.5	7	20	0.9~3.4
VPC8-3R[5]-4B[9]			41.1		18	13		3	0.9~1.9
VPC8-10R[5]-4B			52.6		25	17.5		10	0.8~2.7
VPC8-15R[5]-4B	2.5	10	63.6	8	30	23.5	-	15	0.7~3.0
VPC8-20R[5]-4B			73.6		35	28.5		20	0.9~3.4
VPC8-3R[5]-6B[9]			41.1		18	13		3	0.9~1.9
VPC8-10R[5]-6B	4	10	52.6	8	25	17.5	-	10	0.8~2.7
VPC8-15R[5]-6B			63.6		30	23.5		15	0.7~3.0
VPC8-20R[5]-6B			73.6		35	28.5		20	0.9~3.4
VPC10-6R[5]-4B[9]	2.5	15	56.1	9(10)	26	20	-	6	4.0~7.1
VPC10-10R[5]-4B			60.6		30.5	25		10	2.0~5.2
VPC10-15R[5]-4B			70.6		35.5	25		15	2.0~5.9
VPC10-20R[5]-4B	4	15	86.6	9(10)	42.5	34	-	20	1.1~4.8
VPC10-6R[5]-6B[9]			56.1		26	20		6	4.0~7.1
VPC10-10R[5]-6B			60.6		30.5	25		10	2.0~5.2
VPC10-15R[5]-6B	2.5	15	70.6	9(10)	35.5	25	-	15	2.0~5.9
VPC10-20R[5]-6B			86.6		42.5	34		20	1.1~4.8
VPC15-6R(A)[5]-4B[9]			57.1(58.1)		27(28)	20		6	4.0~7.1
VPC15-10R(A)[5]-4B	61.6(62.6)	31.5(32.5)	25	10	2.0~5.2				
VPC15-15R(A)[5]-4B	71.6(72.6)	36.5(37.5)	25	15	2.0~5.9				
VPC15-20R(A)[5]-4B	87.6(88.6)	43.5(44.5)	34	20	1.1~4.8				
VPC15-6R(A)[5]-6B[9]	4	15	57.1(58.1)	9(10)	27(28)	20	-	6	4.0~7.1
VPC15-10R(A)[5]-6B			61.6(62.6)		31.5(32.5)	25		10	2.0~5.2
VPC15-15R(A)[5]-6B			71.6(72.6)		36.5(37.5)	25		15	2.0~5.9
VPC15-20R(A)[5]-6B	87.6(88.6)	43.5(44.5)	34	20	1.1~4.8				

RoHS Compliant

Copper alloy free available

CAD (2D&3D)

※ .Value in () is the dimension of a deep type pad.

※ [5] : Replaced with Pad rubber material code. Refer to page 492 for details.

※ [9] : Replaced with "-S3" for -S3 spec. (Copper alloy free material for metal parts and FKM or HNBR for sealing parts). -S3 spec. is available for model codes with [9] in the table above.

※ Pad material N, NE, and G are not suitable for use under ozone environment.

※ Tightening torque of a pad holder fixing bulkhead nut is as below.

•Pad dia. : ø1~ø8mm ▶ 1.8~2.4N·m, •Pad dia. : ø10, ø15mm ▶ 4.5~6N·m

※ .See Pisco website for weight information.

Unit : mm

VPC203R(A) 5 6 9
VPC253R(A) 5 6 9
VPC303R(A) 5 6 9
VPC403R(A) 5 6 9
VPC503R(A) 5 6 9

Connection
config. code
-M6

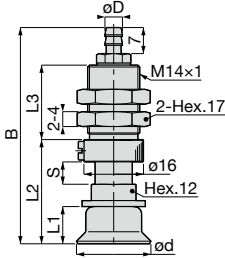

Stroke (mm)
6, 10, 15, 20



RoHS Compliant

Copper alloy free available

CAD (2D&3D)

Model code	Tube I.D. øD	Pad O.D. ød	B	L1	L2	L3	Stroke S	Spring force (N)
VPC20-6R(A) 5-4B 9	2.5	20	58.1(59.1)	10(11)	28(29)	20	6	7.0~12.6
VPC20-10R(A) 5-4B			64.1(65.1)		34(35)		10	3.3~10.0
VPC20-15R(A) 5-4B			74.1(75.1)		39(40)	25	15	3.3~10.4
VPC20-20R(A) 5-4B			90.1(91.1)		46(47)	34	20	2.0~8.7
VPC20-6R(A) 5-6B 9	4	20	58.1(59.1)	10(11)	28(29)	20	6	7.0~12.6
VPC20-10R(A) 5-6B			64.1(65.1)		34(35)		10	3.3~10.0
VPC20-15R(A) 5-6B			74.1(75.1)		39(40)	25	15	3.3~10.4
VPC20-20R(A) 5-6B			90.1(91.1)		46(47)	34	20	2.0~8.7
VPC25-6R(A) 5-4B 9	2.5	25	59.1(60.1)	11(12)	29(30)	20	6	7.0~12.6
VPC25-10R(A) 5-4B			65.1(66.1)		35(36)		10	3.3~10.0
VPC25-15R(A) 5-4B			75.1(76.1)		40(41)	25	15	3.3~10.4
VPC25-20R(A) 5-4B			91.1(92.1)		47(48)	34	20	2.0~8.7
VPC25-6R(A) 5-6B 9	4	25	59.1(60.1)	11(12)	29(30)	20	6	7.0~12.6
VPC25-10R(A) 5-6B			65.1(66.1)		35(36)		10	3.3~10.0
VPC25-15R(A) 5-6B			75.1(76.1)		40(41)	25	15	3.3~10.4
VPC25-20R(A) 5-6B			91.1(92.1)		47(48)	34	20	2.0~8.7
VPC30-6R(A) 5-4B 9	2.5	30	59.1(62.1)	11(14)	29(32)	20	6	7.0~12.6
VPC30-10R(A) 5-4B			65.1(68.1)		35(38)		10	3.3~10.0
VPC30-15R(A) 5-4B			75.1(78.1)		40(43)	25	15	3.3~10.4
VPC30-20R(A) 5-4B			91.1(94.1)		47(50)	34	20	2.0~8.7
VPC30-6R(A) 5-6B 9	4	30	59.1(62.1)	11(14)	29(32)	20	6	7.0~12.6
VPC30-10R(A) 5-6B			65.1(68.1)		35(38)		10	3.3~10.0
VPC30-15R(A) 5-6B			75.1(78.1)		40(43)	25	15	3.3~10.4
VPC30-20R(A) 5-6B			91.1(94.1)		47(50)	34	20	2.0~8.7
VPC40-6R(A) 5-4B 9	2.5	40	62.1(65.6)	14(17.5)	32(35.5)	20	6	7.0~12.6
VPC40-10R(A) 5-4B			68.1(71.6)		38(41.5)		10	3.3~10.0
VPC40-15R(A) 5-4B			78.1(81.6)		43(46.5)	25	15	3.3~10.4
VPC40-20R(A) 5-4B			94.1(97.6)		50(53.5)	34	20	2.0~8.7
VPC40-6R(A) 5-6B 9	4	40	62.1(65.6)	14(17.5)	32(35.5)	20	6	7.0~12.6
VPC40-10R(A) 5-6B			68.1(71.6)		38(41.5)		10	3.3~10.0
VPC40-15R(A) 5-6B			78.1(81.6)		43(46.5)	25	15	3.3~10.4
VPC40-20R(A) 5-6B			94.1(97.6)		50(53.5)	34	20	2.0~8.7
VPC50-6R(A) 5-4B 9	2.5	50	63.1(66.1)	15(18)	33(36)	20	6	7.0~12.6
VPC50-10R(A) 5-4B			69.1(72.1)		39(42)		10	3.3~10.0
VPC50-15R(A) 5-4B			79.1(82.1)		44(47)	25	15	3.3~10.4
VPC50-20R(A) 5-4B			95.1(98.1)		51(54)	34	20	2.0~8.7
VPC50-6R(A) 5-6B 9	4	50	63.1(66.1)	15(18)	33(36)	20	6	7.0~12.6
VPC50-10R(A) 5-6B			69.1(72.1)		39(42)		10	3.3~10.0
VPC50-15R(A) 5-6B			79.1(82.1)		44(47)	25	15	3.3~10.4
VPC50-20R(A) 5-6B			95.1(98.1)		51(54)	34	20	2.0~8.7

※ .Value in () is the dimension of a deep type pad.

※ [5] : Replaced with Pad rubber material code. Refer to page 492 for details.

※ [9] : Replaced with "-S3" for -S3 spec. (Copper alloy free material for metal parts and FKM or HNBR for sealing parts). -S3 spec. is available for model codes with [9] in the table above.

※ Pad material N, NE, and G are not suitable for use under ozone environment.

※ Tightening torque of a pad holder fixing bulkhead nut is as below.

▶ Pad dia. : ø20~ø50mm ▶ 4.5~6N·m

※ See Pisco website for weight information.

VPC Spring type / Top port / Female thread / Standard holder



VPC1-3R-5-M5-9
 VPC2-3R-3-M5-9
 VPC3-3R-3-M5-9
 VPC4-3R-3-M5-9

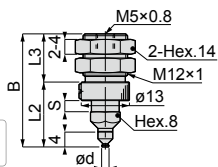

VPC6-3R-5-M5-9
 VPC8-3R-5-M5-9

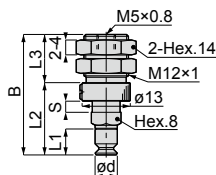

VPC10-3R-5-M6-9
 VPC15-3R(A)-5-M6-9

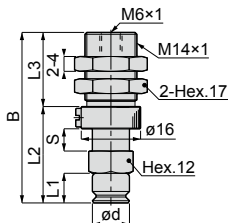

Stroke (mm)
 3, 6, 10, 15, 20

Unit : mm

Model code	Pad O.D. ød	B	L1	L2	L3	Stroke S	Spring force (N)	Connection config. code
VPC1-3R-5-M5-9	1	30.5	-	17.5	13	3	0.9~1.9	-H3
VPC1-10R-5-M5		44.5		27	17.5	10	0.6~1.7	
VPC1-15R-5-M5		55.5		32	23.5	15	0.4~1.7	
VPC1-20R-5-M5		65.5		37	28.5	20	0.3~1.8	
VPC2-3R-5-M5-9	2	30.5	-	17.5	13	3	0.9~1.9	
VPC2-10R-5-M5		44.5		27	17.5	10	0.6~1.7	
VPC2-15R-5-M5		55.5		32	23.5	15	0.4~1.7	
VPC2-20R-5-M5		65.5		37	28.5	20	0.3~1.8	
VPC3-3R-5-M5-9	3	30.5	-	17.5	13	3	0.9~1.9	
VPC3-10R-5-M5		44.5		27	17.5	10	0.6~1.7	
VPC3-15R-5-M5		55.5		32	23.5	15	0.4~1.7	
VPC3-20R-5-M5		65.5		37	28.5	20	0.3~1.8	
VPC4-3R-5-M5-9	4	30.5	-	17.5	13	3	0.9~1.9	
VPC4-10R-5-M5		44.5		27	17.5	10	0.6~1.7	
VPC4-15R-5-M5		55.5		32	23.5	15	0.4~1.7	
VPC4-20R-5-M5		65.5		37	28.5	20	0.3~1.8	
VPC6-3R-5-M5-9	6	32.5	7	19.5	13	3	0.9~1.9	-T8
VPC6-10R-5-M5		44		26.5	17.5	10	0.8~2.7	
VPC6-15R-5-M5		55		31.5	23.5	15	0.7~3.0	
VPC6-20R-5-M5		65		36.5	28.5	20	0.9~3.4	
VPC8-3R-5-M5-9	8	31	5.5	18	13	3	0.9~1.9	
VPC8-10R-5-M5		42.5		25	17.5	10	0.8~2.7	
VPC8-15R-5-M5		53.5		30	23.5	15	0.7~3.0	
VPC8-20R-5-M5		63.5		35	28.5	20	0.9~3.4	
VPC10-6R-5-M6-9	10	46	8	26	20	6	4.0~7.1	-M4
VPC10-10R-5-M6		50.5		30.5		10	2.0~5.2	
VPC10-15R-5-M6		60.5		35.5	25	15	2.0~5.9	
VPC10-20R-5-M6		76.5		42.5	34	20	4.1~4.8	
VPC15-6R(A)-5-M6-9	15	47(48)	9(10)	27(28)	20	6	4.0~7.1	
VPC15-10R(A)-5-M6		51.5(52.5)		31.5(32.5)		10	2.0~5.2	
VPC15-15R(A)-5-M6		61.5(62.5)		36.5(37.5)	25	15	2.0~5.9	
VPC15-20R(A)-5-M6		77.5(78.5)		43.5(44.5)	34	20	4.1~4.8	

RoHS Compliant ~~Copper alloy free available~~ CAD (2D&3D)

VPC20^[3]R(A)^[5]-M6^[9]
VPC25^[3]R(A)^[5]-M6^[9]
VPC30^[3]R(A)^[5]-M6^[9]
VPC40^[3]R(A)^[5]-M6^[9]
VPC50^[3]R(A)^[5]-M6^[9]

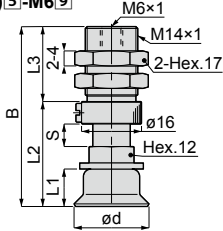

Connection
config. code
-M6

VPC60^[3]R(A)^[5]-G1^[9]
VPC80^[3]R(A)^[5]-G1^[9]
VPC100^[3]R(A)^[5]-G1^[9]
VPC150^[3]R^[5]-G2^[9]
VPC200^[3]R^[5]-G2^[9]

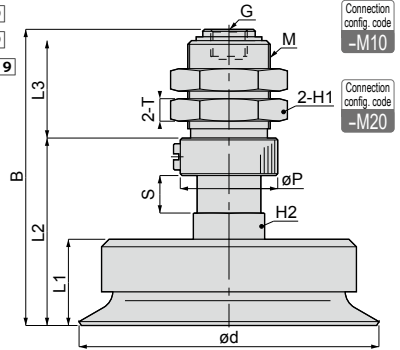

Connection
config. code
-M10

Connection
config. code
-M20

Unit : mm

Model code	Port size G	Pad O.D. ød	Thread M	B	L1	L2	L3	øP	Hex. H1	Hex. H2	T	Stroke S	Spring force (N)
VPC20-6R(A) ^[5] -M6 ^[9]	-	20	-	48(49)	10(11)	28(29)	20	-	-	-	-	6	7.0~12.6
VPC20-10R(A) ^[5] -M6	54(55)			34(35)		10						3.3~10.0	
VPC20-15R(A) ^[5] -M6	64(65)			39(40)		25						15	3.3~10.4
VPC20-20R(A) ^[5] -M6	80(81)			46(47)		34						20	2.0~8.7
VPC25-6R(A) ^[5] -M6 ^[9]	-	25	-	49(50)	11(12)	29(30)	20	-	-	-	-	6	7.0~12.6
VPC25-10R(A) ^[5] -M6	55(56)			35(36)		10						3.3~10.0	
VPC25-15R(A) ^[5] -M6	65(66)			40(41)		25						15	3.3~10.4
VPC25-20R(A) ^[5] -M6	81(82)			47(48)		34						20	2.0~8.7
VPC30-6R(A) ^[5] -M6 ^[9]	-	30	-	49(52)	11(14)	29(32)	20	-	-	-	-	6	7.0~12.6
VPC30-10R(A) ^[5] -M6	55(58)			35(38)		10						3.3~10.0	
VPC30-15R(A) ^[5] -M6	65(68)			40(43)		25						15	3.3~10.4
VPC30-20R(A) ^[5] -M6	81(84)			47(50)		34						20	2.0~8.7
VPC40-6R(A) ^[5] -M6 ^[9]	-	40	-	52(55.5)	14(17.5)	32(35.5)	20	-	-	-	-	6	7.0~12.6
VPC40-10R(A) ^[5] -M6	58(61.5)			38(41.5)		10						3.3~10.0	
VPC40-15R(A) ^[5] -M6	68(71.5)			43(46.5)		25						15	3.3~10.4
VPC40-20R(A) ^[5] -M6	84(87.5)			50(53.5)		34						20	2.0~8.7
VPC50-6R(A) ^[5] -M6 ^[9]	-	50	-	53(56)	15(18)	33(36)	20	-	-	-	-	6	7.0~12.6
VPC50-10R(A) ^[5] -M6	59(62)			39(42)		10						3.3~10.0	
VPC50-15R(A) ^[5] -M6	69(72)			44(47)		25						15	3.3~10.4
VPC50-20R(A) ^[5] -M6	85(88)			51(54)		34						20	2.0~8.7
VPC60-10R(A) ^[5] -G1 ^[9]	G1/8	60	M22×1	76.6(83.6)	18(25)	47.6(54.6)	26	26	27	19	6	10	10.1~15.8
VPC80-10R(A) ^[5] -G1 ^[9]	G1/8	80	M22×1	79(89)	23(33)	50(60)	26	26	27	19	6	10	10.1~15.8
VPC100-10R(A) ^[5] -G1 ^[9]	G1/8	100	M22×1	81(90)	25(34)	52(61)	26	26	27	19	6	10	10.1~15.8
VPC150-20R ^[5] -G2 ^[9]	G1/4	150	M30×2	164	45	112.1	48	35	36	30	10	20.1	14.0~25.5
VPC200-20R ^[5] -G2 ^[9]	G1/4	200	M30×2	169	50	117.1	48	35	36	30	10	20.1	14.0~25.5

- ※ Value in () is the dimension of a deep type pad.
- ※ [5] : Replaced with Pad rubber material code. Refer to page 492 for details.
- ※ [9] : Replaced with "-S3" for -S3 spec. (Copper alloy free material for metal parts and FKM or HNBR for sealing parts). -S3 spec. is available for model codes with [9] in the table above.
- ※ Pad material N, NE, and G are not suitable for use under ozone environment.
- ※ Tightening torque of a pad holder fixing bulkhead nut is as below.
 •Pad dia. : ø1~ø8mm ▶ 8~10N·m. •Pad dia. : ø10~ø50mm ▶ 4.5~6N·m.
 •Pad dia. : ø60~ø100mm ▶ 16~20N·m. •Pad dia. : ø150~ø200mm ▶ 42~54N·m
- ※ See Pisco website for weight information.



VPOC Spring type / Top port / Push-in fitting / No cover holder

RoHS Compliant CAD (2D&3D)

Stroke (mm)
20,30,40,50

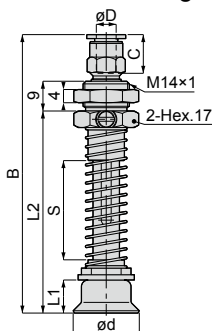

Unit : mm

Model code	Tube O.D. ϕD	Pad O.D. ϕd	B	L1	L2	Tube end C	Stroke S	Spring force (N)	Connection config. code	
VPOC20-20R(A)S-3J	3	20	69.7(70.7)	10(11)	48(49)	10.9	20	1.5~4.9	-M6	
VPOC20-20R(A)S-4J	4		71.1(72.1)			11.7				
VPOC20-20R(A)S-6J	6		82.7(83.7)		61(62)	10.9	30	1.1~4.8		
VPOC20-30R(A)S-3J	3		84.1(85.1)			11.7				
VPOC20-30R(A)S-4J	4		95.7(96.7)		74(75)	10.9	40	1.0~4.5		
VPOC20-30R(A)S-6J	6		97.1(98.1)			11.7				
VPOC20-40R(A)S-3J	3		108.7(109.7)		87(88)	10.9	50	0.9~4.5		
VPOC20-40R(A)S-4J	4		110.1(111.1)			11.7				
VPOC20-50R(A)S-6J	6		70.7(71.7)		11(12)	49(50)	10.9	20		1.5~4.9
VPOC25-20R(A)S-3J	3		72.1(73.1)				11.7			
VPOC25-20R(A)S-4J	4		83.7(84.7)			62(63)	10.9	30		1.1~4.8
VPOC25-30R(A)S-3J	3		85.1(86.1)				11.7			
VPOC25-30R(A)S-4J	4	96.7(97.7)	75(76)	10.9		40	1.0~4.5			
VPOC25-40R(A)S-3J	3	98.1(99.1)		11.7						
VPOC25-40R(A)S-4J	4	109.7(110.7)	88(89)	10.9		50	0.9~4.5			
VPOC25-50R(A)S-3J	3	111.1(112.1)		11.7						
VPOC25-50R(A)S-4J	4	70.7(73.7)	11(14)	49(52)		10.9	20	1.5~4.9		
VPOC30-20R(A)S-3J	3	72.1(75.1)				11.7				
VPOC30-20R(A)S-4J	4	83.7(86.7)		62(65)		10.9	30	1.1~4.8		
VPOC30-30R(A)S-3J	3	85.1(88.1)				11.7				
VPOC30-30R(A)S-4J	4	96.7(99.7)		75(78)	10.9	40	1.0~4.5			
VPOC30-40R(A)S-3J	3	98.1(101.1)			11.7					
VPOC30-40R(A)S-4J	4	109.7(112.7)		88(91)	10.9	50	0.9~4.5			
VPOC30-50R(A)S-3J	3	111.1(114.1)			11.7					
VPOC30-50R(A)S-4J	4									
VPOC30-50R(A)S-6J	6									

Unit : mm

Model code	Tube O.D. øD	Pad O.D. ød	B	L1	L2	Tube end C	Stroke S	Spring force (N)	Connection config. code		
VPOC40-20R(A)S-3J	3	40	73.7(77.2)	14(17.5)	52(55.5)	10.9	20	1.5~4.9	-M6		
VPOC40-20R(A)S-4J	4					11.7					
VPOC40-20R(A)S-6J	6		75.1(78.6)		65(68.5)	10.9	30	1.1~4.8			
VPOC40-30R(A)S-3J	3					11.7					
VPOC40-30R(A)S-4J	4		86.7(90.2)		78(81.5)	10.9	40	1.0~4.5			
VPOC40-30R(A)S-6J	6		88.1(91.6)			11.7					
VPOC40-40R(A)S-3J	3		99.7(103.2)		91(94.5)	10.9	50	0.9~4.5			
VPOC40-40R(A)S-4J	4		101.1(104.6)			11.7					
VPOC40-40R(A)S-6J	6		112.7(116.2)		114.1(117.6)	11.7	11.7	11.7			
VPOC40-50R(A)S-3J	3		114.1(117.6)								
VPOC40-50R(A)S-4J	4		50		74.7(77.7)	15(18)	53(56)	10.9		20	1.5~4.9
VPOC50-20R(A)S-4J	4							11.7			
VPOC50-20R(A)S-6J	6	76.1(79.1)		66(69)	10.9		30	1.1~4.8			
VPOC50-30R(A)S-3J	3				11.7						
VPOC50-30R(A)S-4J	4	87.7(90.7)		79(82)	10.9		40	1.0~4.5			
VPOC50-30R(A)S-6J	6	89.1(92.1)			11.7						
VPOC50-40R(A)S-3J	3	100.7(103.7)		92(95)	10.9		50	0.9~4.5			
VPOC50-40R(A)S-4J	4	102.1(105.1)			11.7						
VPOC50-40R(A)S-6J	6	113.7(116.7)		115.1(118.1)	11.7		11.7	11.7			
VPOC50-50R(A)S-3J	3	115.1(118.1)									
VPOC50-50R(A)S-4J	4										
VPOC50-50R(A)S-6J	6										

VPOC Spring type / Top port / Barb fitting / No cover holder

RoHS Compliant CAD (2D&3D)

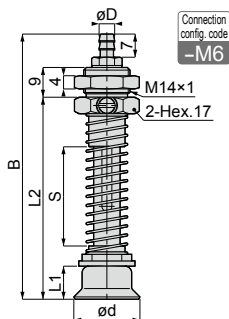

Stroke (mm)
20,30,40,50



Unit : mm

Model code	Tube I.D. øD	Pad O.D. ød	B	L1	L2	Stroke S	Spring force (N)	
VPOC20-20R(A) [5]-4B	2.5	20	67.1(68.1)	10(11)	48(49)	20	1.5~4.9	
VPOC20-20R(A) [5]-6B	4							
VPOC20-30R(A) [5]-4B	2.5							
VPOC20-30R(A) [5]-6B	4		61(62)		30	1.1~4.8		
VPOC20-40R(A) [5]-4B	2.5							
VPOC20-40R(A) [5]-6B	4							
VPOC20-50R(A) [5]-4B	2.5	106.1(107.1)	87(88)	50	0.9~4.5			
VPOC20-50R(A) [5]-6B	4							
VPOC25-20R(A) [5]-4B	2.5					25	68.1(69.1)	11(12)
VPOC25-20R(A) [5]-6B	4							
VPOC25-30R(A) [5]-4B	2.5							
VPOC25-30R(A) [5]-6B	4	81.1(82.1)	62(63)	30	1.1~4.8			
VPOC25-40R(A) [5]-4B	2.5							
VPOC25-40R(A) [5]-6B	4							
VPOC25-50R(A) [5]-4B	2.5	107.1(108.1)	88(89)	50	0.9~4.5			
VPOC25-50R(A) [5]-6B	4							
VPOC30-20R(A) [5]-4B	2.5					30	68.1(71.1)	11(14)
VPOC30-20R(A) [5]-6B	4							
VPOC30-30R(A) [5]-4B	2.5							
VPOC30-30R(A) [5]-6B	4	81.1(84.1)	62(65)	30	1.1~4.8			
VPOC30-40R(A) [5]-4B	2.5							
VPOC30-40R(A) [5]-6B	4							
VPOC30-50R(A) [5]-4B	2.5	107.1(110.1)	88(91)	50	0.9~4.5			
VPOC30-50R(A) [5]-6B	4							
VPOC40-20R(A) [5]-4B	2.5					40	71.1(74.6)	14(17.5)
VPOC40-20R(A) [5]-6B	4							
VPOC40-30R(A) [5]-4B	2.5							
VPOC40-30R(A) [5]-6B	4	84.1(87.6)	65(68.5)	30	1.1~4.8			
VPOC40-40R(A) [5]-4B	2.5							
VPOC40-40R(A) [5]-6B	4							
VPOC40-50R(A) [5]-4B	2.5	110.1(113.6)	91(94.5)	50	0.9~4.5			
VPOC40-50R(A) [5]-6B	4							
VPOC50-20R(A) [5]-4B	2.5					50	72.1(75.1)	15(18)
VPOC50-20R(A) [5]-6B	4							
VPOC50-30R(A) [5]-4B	2.5							
VPOC50-30R(A) [5]-6B	4	85.1(88.1)	66(69)	30	1.1~4.8			
VPOC50-40R(A) [5]-4B	2.5							
VPOC50-40R(A) [5]-6B	4							
VPOC50-50R(A) [5]-4B	2.5	111.1(114.1)	92(95)	50	0.9~4.5			
VPOC50-50R(A) [5]-6B	4							

※ .Value in () is the dimension of a deep type pad.

※ [5] : Replaced with Pad rubber material code. Refer to page 820 for details.

※ .Tightening torque of a pad holder fixing bulkhead nut : 4.5~6N·m.

※ .See Pisco website for weight information.

VPOC Spring type / Top part / Female thread / No cover holder

RoHS Compliant CAD (2D&3D)

Unit : mm

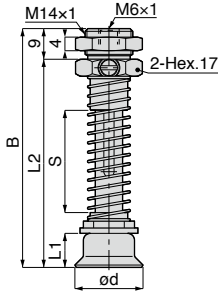

Stroke (mm)
20,30,40,50



Model code	Pad O.D. ød	B	L1	L2	Stroke S	Spring force (N)	Connection config. code
VPOC20-20R(A)S-M6	20	57(58)	10(11)	48(49)	20	1.5~4.9	-M6
VPOC20-30R(A)S-M6		70(71)		61(62)	30	1.1~4.8	
VPOC20-40R(A)S-M6		83(84)		74(75)	40	1.0~4.5	
VPOC20-50R(A)S-M6		96(97)		87(88)	50	0.9~4.5	
VPOC25-20R(A)S-M6	25	58(59)	11(12)	49(50)	20	1.5~4.9	
VPOC25-30R(A)S-M6		71(72)		62(63)	30	1.1~4.8	
VPOC25-40R(A)S-M6		84(85)		75(76)	40	1.0~4.5	
VPOC25-50R(A)S-M6		97(98)		88(89)	50	0.9~4.5	
VPOC30-20R(A)S-M6	30	58(61)	11(14)	49(52)	20	1.5~4.9	
VPOC30-30R(A)S-M6		71(74)		62(65)	30	1.1~4.8	
VPOC30-40R(A)S-M6		84(87)		75(78)	40	1.0~4.5	
VPOC30-50R(A)S-M6		97(100)		88(91)	50	0.9~4.5	
VPOC40-20R(A)S-M6	40	61(64.5)	14(17.5)	52(55.5)	20	1.5~4.9	
VPOC40-30R(A)S-M6		74(77.5)		65(68.5)	30	1.1~4.8	
VPOC40-40R(A)S-M6		87(90.5)		78(81.5)	40	1.0~4.5	
VPOC40-50R(A)S-M6		100(103.5)		91(94.5)	50	0.9~4.5	
VPOC50-20R(A)S-M6	50	62(65)	15(18)	53(56)	20	1.5~4.9	
VPOC50-30R(A)S-M6		75(78)		66(69)	30	1.1~4.8	
VPOC50-40R(A)S-M6		88(91)		79(82)	40	1.0~4.5	
VPOC50-50R(A)S-M6		101(104)		92(95)	50	0.9~4.5	

※ .Value in () is the dimension of a deep type pad.

※ .S : Replaced with Pad rubber material code. Refer to page 820 for details.

※ .Tightening torque of a pad holder fixing bulkhead nut : 4.5~6N·m.

※ .See Pisco website for weight information.



VPMD Spring type / Side port / Push-in fitting / Mini holder

VPMD0.7-2RM [5][6][9]

VPMD1-2RM [5][6][9]

VPMD1.5-2RM [5][6][9]

VPMD2-2RM [5][6][9]

VPMD3-2RM [5][6][9]

VPMD4-2RM [5][6][9]

VPMD6-2R [5][6][9]

VPMD8-2R [5][6][9]

VPMD10-4R(A) [5][6][9]

VPMD15-4R(A) [5][6][9]

VPMD20-4R(A) [5][6][9]

VPMD25-4R(A) [5][6][9]

VPMD30-4R(A) [5][6][9]

VPMD40-4R(A) [5][6][9]

VPMD50-4R(A) [5][6][9]

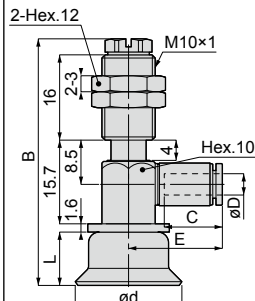
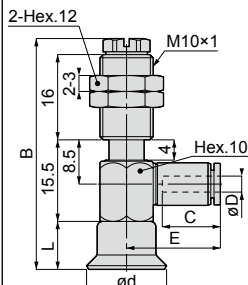
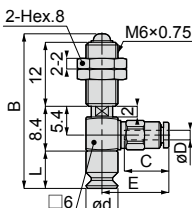
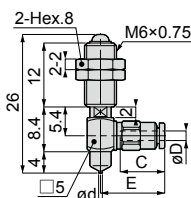

Unit : mm

Model code	Tube O.D. øD	Pad O.D. ød	B	L	Tube end C	E	Spring force (N)	Connection config. code
VPMD0.7-2RM [5]-180J	1.8	0.7	—	—	8.4	12.1	0.2 ~ 0.3	—
VPMD0.7-2RM [5]-2J	2				13.1			
VPMD0.7-2RM [5]-3J	3				13.1			
VPMD0.7-2RM [5]-4J [9]	4				15.1			
VPMD1-2RM [5]-180J	1.8	1	—	—	8.4	12.1	0.2 ~ 0.3	—
VPMD1-2RM [5]-2J	2				13.1			
VPMD1-2RM [5]-3J	3				13.1			
VPMD1-2RM [5]-4J [9]	4				15.1			
VPMD1.5-2RM [5]-180J	1.8	1.5	—	—	8.4	12.1	0.2 ~ 0.3	—
VPMD1.5-2RM [5]-2J	2				13.1			
VPMD1.5-2RM [5]-3J	3				13.1			
VPMD1.5-2RM [5]-4J [9]	4				15.1			
VPMD2-2RM [5]-180J	1.8	2	—	—	8.4	12.1	0.2 ~ 0.3	-T4
VPMD2-2RM [5]-2J	2				13.1			
VPMD2-2RM [5]-3J	3				13.1			
VPMD2-2RM [5]-4J [9]	4				15.1			
VPMD3-2RM [5]-180J	1.8	3	—	—	8.4	12.1	0.2 ~ 0.3	—
VPMD3-2RM [5]-2J	2				13.1			
VPMD3-2RM [5]-3J	3				13.1			
VPMD3-2RM [5]-4J [9]	4				15.1			
VPMD4-2RM [5]-180J	1.8	4	—	—	8.4	12.1	0.2 ~ 0.3	—
VPMD4-2RM [5]-2J	2				13.1			
VPMD4-2RM [5]-3J	3				13.1			
VPMD4-2RM [5]-4J [9]	4				15.1			
VPMD6-2R [5]-180J	1.8	6	29	7	8.4	12.6	0.5 ~ 0.6	-T8
VPMD6-2R [5]-2J	2				13.6			
VPMD6-2R [5]-3J	3				13.6			
VPMD6-2R [5]-4J [9]	4				15.6			

Stroke (mm)
2, 4

RoHS Compliant Copper alloy free available CAD (2D&3D)

Unit : mm

Model code	Tube O.D. øD	Pad O.D. ød	B	L	Tube end C	E	Spring force (N)	Connection config. code
VPMD8-2R(S)-180J	1.8	8	27.5	5.5	8.4	12.6	0.5 ~ 0.6	-T8
VPMD8-2R(S)-2J	2				9.4	13.6		
VPMD8-2R(S)-3J	3							
VPMD8-2R(S)-4J ^⑨	4							
VPMD10-4R(S)-180J	1.8	10	42.5	8	8.4	13.7	1 ~ 1.3	-M4
VPMD10-4R(S)-2J	2				10.9	17.5		
VPMD10-4R(S)-3J	3							
VPMD10-4R(S)-4J ^⑨	4							
VPMD10-4R(S)-6J ^⑨	6							
VPMD15-4R(A)(S)-180J	1.8	15	43.5(44.5)	9(10)	8.4	13.7	1 ~ 1.3	
VPMD15-4R(A)(S)-2J	2				10.9	17.5		
VPMD15-4R(A)(S)-3J	3							
VPMD15-4R(A)(S)-4J ^⑨	4							
VPMD15-4R(A)(S)-6J ^⑨	6							
VPMD20-4R(A)(S)-180J	1.8	20	46.3(47.3)	10(11)	8.4	13.7	1 ~ 1.3	
VPMD20-4R(A)(S)-2J	2				10.9	17.5		
VPMD20-4R(A)(S)-3J	3							
VPMD20-4R(A)(S)-4J ^⑨	4							
VPMD20-4R(A)(S)-6J ^⑨	6							
VPMD25-4R(A)(S)-180J	1.8	25	47.3(48.3)	11(12)	8.4	13.7	1 ~ 1.3	
VPMD25-4R(A)(S)-2J	2				10.9	17.5		
VPMD25-4R(A)(S)-3J	3							
VPMD25-4R(A)(S)-4J ^⑨	4							
VPMD25-4R(A)(S)-6J ^⑨	6							
VPMD30-4R(A)(S)-180J	1.8	30	47.3(50.3)	11(14)	8.4	13.7	1 ~ 1.3	-M6
VPMD30-4R(A)(S)-2J	2				10.9	17.5		
VPMD30-4R(A)(S)-3J	3							
VPMD30-4R(A)(S)-4J ^⑨	4							
VPMD30-4R(A)(S)-6J ^⑨	6							
VPMD40-4R(A)(S)-180J	1.8	40	50.3(53.8)	14(17.5)	8.4	13.7	1 ~ 1.3	
VPMD40-4R(A)(S)-2J	2				10.9	17.5		
VPMD40-4R(A)(S)-3J	3							
VPMD40-4R(A)(S)-4J ^⑨	4							
VPMD40-4R(A)(S)-6J ^⑨	6							
VPMD50-4R(A)(S)-180J	1.8	50	51.3(54.3)	15(18)	8.4	13.7	1 ~ 1.3	
VPMD50-4R(A)(S)-2J	2				10.9	17.5		
VPMD50-4R(A)(S)-3J	3							
VPMD50-4R(A)(S)-4J ^⑨	4							
VPMD50-4R(A)(S)-6J ^⑨	6							

※ .Value in () is the dimension of a deep type pad.

※ (S) : Replaced with Pad rubber material code. Refer to page 492 for details.

※ (A) : Replaced with "-S3" for -S3 spec. (Copper alloy free material for metal parts and FKM or HNBR for sealing parts). -S3 spec. is available for model codes with (9) in the table above. -S3 spec. is available for Tube O.D. : ø1.8 and ø3mm.

※ .Pad material N, NE, and G are not suitable for use under ozone environment.

※ .Tightening torque of a pad holder fixing bulkhead nut is as below.

•Pad dia. : ø0.7~ø8mm ▶ 2.5~3.5N·m. •Pad dia. : ø10~ø50mm ▶ 4~6N·m

※ .See Pisco website for weight information.



VPMD Spring type / Side port / Barb fitting / Mini holder

VPMD0.7-2RM [5][6][9]

VPMD1-2RM [5][6][9]

VPMD1.5-2RM [5][6][9]

VPMD2-2RM [5][6][9]

VPMD3-2RM [5][6][9]

VPMD4-2RM [5][6][9]

VPMD6-2R [5][6][9]

VPMD8-2R [5][6][9]

VPMD10-4R(A) [5][6][9]

VPMD15-4R(A) [5][6][9]

VPMD20-4R(A) [5][6][9]

VPMD25-4R(A) [5][6][9]

VPMD30-4R(A) [5][6][9]

VPMD40-4R(A) [5][6][9]

VPMD50-4R(A) [5][6][9]

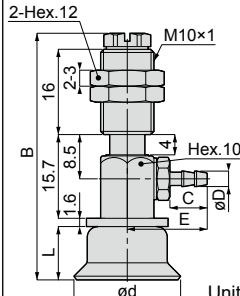
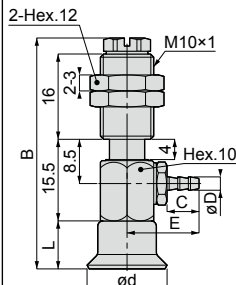
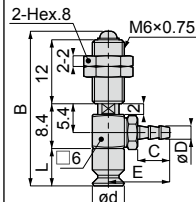
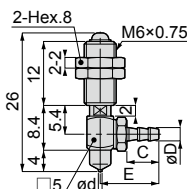

Unit : mm

Model code	Tube I.D. øD	Pad O.D. øD	B	L	E	C	Spring force (N)	Connection config. code
VPMD0.7-2RM [5]-3B [9]	2	0.7	-	-	11	6	0.2 ~ 0.3	-T4
VPMD0.7-2RM [5]-4B [9]	2.5				12	7		
VPMD0.7-2RM [5]-6B [9]	4				12	7		
VPMD1-2RM [5]-3B [9]	2	1	-	-	11	6	0.2 ~ 0.3	
VPMD1-2RM [5]-4B [9]	2.5				12	7		
VPMD1-2RM [5]-6B [9]	4				12	7		
VPMD1.5-2RM [5]-3B [9]	2	1.5	-	-	11	6	0.2 ~ 0.3	
VPMD1.5-2RM [5]-4B [9]	2.5				12	7		
VPMD1.5-2RM [5]-6B [9]	4				12	7		
VPMD2-2RM [5]-3B [9]	2	2	-	-	11	6	0.2 ~ 0.3	
VPMD2-2RM [5]-4B [9]	2.5				12	7		
VPMD2-2RM [5]-6B [9]	4				12	7		
VPMD3-2RM [5]-3B [9]	2	3	-	-	11	6	0.2 ~ 0.3	
VPMD3-2RM [5]-4B [9]	2.5				12	7		
VPMD3-2RM [5]-6B [9]	4				12	7		
VPMD4-2RM [5]-3B [9]	2	4	-	-	11	6	0.2 ~ 0.3	
VPMD4-2RM [5]-4B [9]	2.5				12	7		
VPMD4-2RM [5]-6B [9]	4				12	7		
VPMD6-2R [5]-3B [9]	2	6	29	7	11.5	6	0.5 ~ 0.6	-T8
VPMD6-2R [5]-4B [9]	2.5				12.5	7		
VPMD6-2R [5]-6B [9]	4				12.5	7		
VPMD8-2R [5]-3B [9]	2	8	27.5	5.5	11.5	6	0.5 ~ 0.6	
VPMD8-2R [5]-4B [9]	2.5				12.5	7		
VPMD8-2R [5]-6B [9]	4				12.5	7		
VPMD10-4R [5]-3B [9]	2	10	42.5	8	13.4	6	1 ~ 1.3	-M4
VPMD10-4R [5]-4B [9]	2.5				14.9	7		
VPMD10-4R [5]-6B [9]	4				14.9	7		
VPMD15-4R(A) [5]-3B [9]	2	15	43.5(44.5)	9(10)	13.4	6	1 ~ 1.3	
VPMD15-4R(A) [5]-4B [9]	2.5				14.9	7		
VPMD15-4R(A) [5]-6B [9]	4				14.9	7		

↑↓ Stroke (mm)
2, 4

RoHS Compliant ✕ Copper alloy free available ✎ CAD (2D&3D)

Unit : mm

Model code	Tube I.D. øD	Pad O.D. ød	B	L	E	C	Spring force (N)	Connection config. code
VPMD20-4R(A)S-3B9	2	20	46.3(47.3)	10(11)	13.4	6	1 ~ 1.3	-M6
VPMD20-4R(A)S-4B9	2.5				14.9	7		
VPMD20-4R(A)S-6B9	4				14.9	7		
VPMD25-4R(A)S-3B9	2	25	47.3(48.3)	11(12)	13.4	6	1 ~ 1.3	
VPMD25-4R(A)S-4B9	2.5				14.9	7		
VPMD25-4R(A)S-6B9	4				14.9	7		
VPMD30-4R(A)S-3B9	2	30	47.3(50.3)	11(14)	13.4	6	1 ~ 1.3	
VPMD30-4R(A)S-4B9	2.5				14.9	7		
VPMD30-4R(A)S-6B9	4				14.9	7		
VPMD40-4R(A)S-3B9	2	40	50.3(53.8)	14(17.5)	13.4	6	1 ~ 1.3	
VPMD40-4R(A)S-4B9	2.5				14.9	7		
VPMD40-4R(A)S-6B9	4				14.9	7		
VPMD50-4R(A)S-3B9	2	50	51.3(54.3)	15(18)	13.4	6	1 ~ 1.3	
VPMD50-4R(A)S-4B9	2.5				14.9	7		
VPMD50-4R(A)S-6B9	4				14.9	7		

※ .Value in () is the dimension of a deep type pad.

※ .S: Replaced with Pad rubber material code. Refer to page 492 for details.

※ .9: Replaced with "-S3" for -S3 spec. (Copper alloy free material for metal parts and FKM or HNBR for sealing parts). -S3 spec. is available for model codes with 9 in the table above.

※ .Pad material N, NE, and G are not suitable for use under ozone environment.

※ .Tightening torque of a pad holder fixing bulkhead nut is as below.

•Pad dia. : ø0.7~ø8mm ▶ 2.5~3.5N·m, •Pad dia. : ø10~ø50mm ▶ 4~6N·m

※ .See Pisco website for weight information.

VPMD Spring type / Side port / Female thread / Mini holder

RoHS Compliant ~~X~~ Copper alloy free available  CAD (2D&3D)

VPMD0.7-2RM [5]-M3 [9]

VPMD1-2RM [5]-M3 [9]

VPMD1.5-2RM [5]-M3 [9]

VPMD2-2RM [5]-M3 [9]

VPMD3-2RM [5]-M3 [9]

VPMD4-2RM [5]-M3 [9]

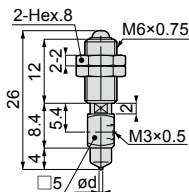

VPMD6-2R [5]-M3 [9]

VPMD8-2R [5]-M3 [9]

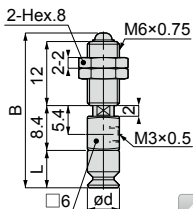

VPMD10-4R(A) [5]-M5 [9]

VPMD15-4R(A) [5]-M5 [9]

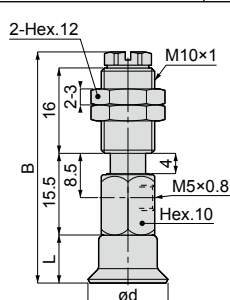

VPMD20-4R(A) [5]-M5 [9]

VPMD25-4R(A) [5]-M5 [9]

VPMD30-4R(A) [5]-M5 [9]

VPMD40-4R(A) [5]-M5 [9]

VPMD50-4R(A) [5]-M5 [9]

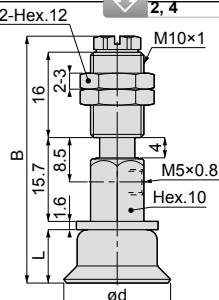

Unit : mm

Model code	Pad O.D. ød	B	L	Spring force (N)	Connection config. code
VPMD0.7-2RM [5]-M3 [9]	0.7	—	—	0.2 ~ 0.3	-T4
VPMD1-2RM [5]-M3 [9]	1	—	—	0.2 ~ 0.3	
VPMD1.5-2RM [5]-M3 [9]	1.5	—	—	0.2 ~ 0.3	
VPMD2-2RM [5]-M3 [9]	2	—	—	0.2 ~ 0.3	
VPMD3-2RM [5]-M3 [9]	3	—	—	0.2 ~ 0.3	
VPMD4-2RM [5]-M3 [9]	4	—	—	0.2 ~ 0.3	
VPMD6-2R [5]-M3 [9]	6	29	7	0.5 ~ 0.6	-T8
VPMD8-2R [5]-M3 [9]	8	27.5	5.5	0.5 ~ 0.6	
VPMD10-4R [5]-M5 [9]	10	42.5	8	1 ~ 1.3	-M4
VPMD15-4R(A) [5]-M5 [9]	15	43.5(44.5)	9(10)	1 ~ 1.3	
VPMD20-4R(A) [5]-M5 [9]	20	46.3(47.3)	11.6(12.6)	1 ~ 1.3	-M6
VPMD25-4R(A) [5]-M5 [9]	25	47.3(48.3)	12.6(13.6)	1 ~ 1.3	
VPMD30-4R(A) [5]-M5 [9]	30	47.3(50.3)	12.6(15.6)	1 ~ 1.3	
VPMD40-4R(A) [5]-M5 [9]	40	50.3(53.8)	15.6(19.1)	1 ~ 1.3	
VPMD50-4R(A) [5]-M5 [9]	50	51.3(54.3)	16.6(19.6)	1 ~ 1.3	

※ [5]: Replaced with Pad rubber material code. Refer to page 492 for details.

※ [9]: Replaced with "-S3" for -S3 spec. (Copper alloy free material for metal parts and FKM or HNBR for sealing parts).

※ Pad material N, NE, and G are not suitable for use under ozone environment.

※ Tightening torque of a pad holder fixing bulkhead nut is as below.

•Pad dia. : ø0.7~ø8mm ▶ 2.5~3.5N·m, •Pad dia. : ø10~ø50mm ▶ 4~6N·m

※ See Pisco website for weight information.



VPD Spring type / Side port / Push-in fitting / Standard holder

Unit : mm

VPD1-3R[5][6][9]

VPD2-3R[5][6][9]

Connection
config. code
-H3

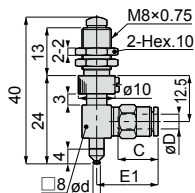

VPD1[3]R[5][6][9]

VPD2[3]R[5][6][9]

Connection
config. code
-H3

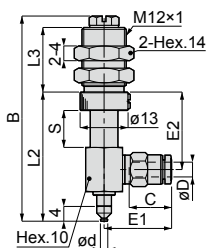

Stroke (mm)
3, 10, 15, 20

Model code	Tube O.D. øD	Pad O.D. ød	B	L2	L3	Tube end C	E1	E2	Stroke S	Spring force (N)													
VPD1-3R[5]-180J	1.8	1	—	—	—	8.4	12.7	—	—	0.9~1.9													
VPD1-3R[5]-2J	2					10.9	16.5																
VPD1-3R[5]-3J	3										11.7	18.4											
VPD1-3R[5]-4J[9]	4												8.4	13.7									
VPD1-3R[5]-6J[9]	6														10.9	17.5							
VPD1-10R[5]-180J	1.8																55.6	35	17.5	21	10		
VPD1-10R[5]-2J	2		10.9	17.5																			
VPD1-10R[5]-3J	3				11.7	18.9																	
VPD1-10R[5]-4J[9]	4						8.4	13.7															
VPD1-10R[5]-6J[9]	6								10.9		17.5												
VPD1-15R[5]-180J	1.8											2	66.6	40	23.5	8.4						13.7	26
VPD1-15R[5]-2J	2																10.9	17.5					
VPD1-15R[5]-3J	3	11.7	18.9																				
VPD1-15R[5]-4J[9]	4			8.4	13.7																		
VPD1-15R[5]-6J[9]	6					10.9	17.5																
VPD1-20R[5]-180J	1.8							76.6	45	28.5	8.4								13.7	31	20		
VPD1-20R[5]-2J	2												10.9	17.5									
VPD1-20R[5]-3J	3														11.7	18.9							
VPD1-20R[5]-4J[9]	4	8.4	12.7																				
VPD1-20R[5]-6J[9]	6			10.9	16.5																		
VPD2-3R[5]-180J	1.8					2	—										—	—				8.4	12.7
VPD2-3R[5]-2J	2							10.9	16.5														
VPD2-3R[5]-3J	3									11.7	18.4												
VPD2-3R[5]-4J[9]	4											8.4	13.7										
VPD2-3R[5]-6J[9]	6	10.9	17.5																				
VPD2-10R[5]-180J	1.8			55.6	35									17.5	8.4	13.7			21	10			
VPD2-10R[5]-2J	2																				10.9	17.5	
VPD2-10R[5]-3J	3							11.7	18.9														
VPD2-10R[5]-4J[9]	4									8.4	13.7												
VPD2-10R[5]-6J[9]	6											10.9	17.5										
VPD2-15R[5]-180J	1.8	66.6	40																				23.5
VPD2-15R[5]-2J	2			10.9	17.5																		
VPD2-15R[5]-3J	3						11.7							18.9									
VPD2-15R[5]-4J[9]	4							8.4	13.7														
VPD2-15R[5]-6J[9]	6									10.9	17.5												
VPD2-20R[5]-180J	1.8											76.6	45		28.5	8.4	13.7	31	20				
VPD2-20R[5]-2J	2		10.9																	17.5			
VPD2-20R[5]-3J	3			11.7	18.9																		
VPD2-20R[5]-4J[9]	4						8.4							12.7									
VPD2-20R[5]-6J[9]	6							10.9	16.5														

547

- RoHS Compliant
- Copper alloy free available
- CAD (2D&3D)

※ [5]: Replaced with Pad rubber material code. Refer to page 492 for details.
 ※ [9]: Replaced with "-S3" for -S3 spec. (Copper alloy free material for metal parts and FKM or HNBR for sealing parts). -S3 spec. is available for model codes with 9 in the table above.
 ※ Pad material N, NE, and G are not suitable for use under ozone environment.
 ※ Tightening torque of a pad holder fixing bulkhead nut is as below.
 *Pad dia. : ø1~ø4mm ▶ 1.8~2.4N·m
 ※ See Pisco website for weight information.

Unit : mm

VPD3-3R[5][6][9]
VPD4-3R[5][6][9]

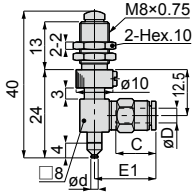

Connection
config. code
-H3

VPD3[3]R[5][6][9]
VPD4[3]R[5][6][9]

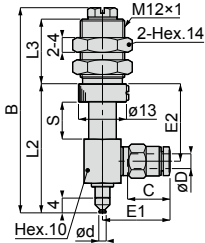

Connection
config. code
-H3

Stroke (mm)
3, 10, 15, 20

Model code	Tube O.D. øD	Pad O.D. ød	B	L2	L3	Tube end C	E1	E2	Stroke S	Spring force (N)
VPD3-3R[5]-180J	1.8	3	—	—	—	8.4	12.7	—	—	0.9~1.9
VPD3-3R[5]-2J	2					10.9	16.5			
VPD3-3R[5]-3J	3									
VPD3-3R[5]-4J[9]	4									
VPD3-3R[5]-6J[9]	6					11.7	18.4			
VPD3-10R[5]-180J	1.8					55.6	35			
VPD3-10R[5]-2J	2		10.9	17.5						
VPD3-10R[5]-3J	3									
VPD3-10R[5]-4J[9]	4									
VPD3-10R[5]-6J[9]	6		11.7	18.9						
VPD3-15R[5]-180J	1.8		66.6	40	23.5			8.4	13.7	
VPD3-15R[5]-2J	2					10.9	17.5			
VPD3-15R[5]-3J	3									
VPD3-15R[5]-4J[9]	4									
VPD3-15R[5]-6J[9]	6	11.7				18.9				
VPD3-20R[5]-180J	1.8	76.6				45	28.5	8.4	13.7	31
VPD3-20R[5]-2J	2		10.9	17.5						
VPD3-20R[5]-3J	3									
VPD3-20R[5]-4J[9]	4									
VPD3-20R[5]-6J[9]	6		11.7	18.9						
VPD4-3R[5]-180J	1.8		4	—	—			—	8.4	
VPD4-3R[5]-2J	2	10.9				16.5				
VPD4-3R[5]-3J	3									
VPD4-3R[5]-4J[9]	4									
VPD4-3R[5]-6J[9]	6	11.7				18.4				
VPD4-10R[5]-180J	1.8	55.6				35	17.5		8.4	13.7
VPD4-10R[5]-2J	2			10.9	17.5					
VPD4-10R[5]-3J	3									
VPD4-10R[5]-4J[9]	4									
VPD4-10R[5]-6J[9]	6			11.7	18.9					
VPD4-15R[5]-180J	1.8			66.6	40			23.5	8.4	13.7
VPD4-15R[5]-2J	2	10.9				17.5				
VPD4-15R[5]-3J	3									
VPD4-15R[5]-4J[9]	4									
VPD4-15R[5]-6J[9]	6	11.7	18.9							
VPD4-20R[5]-180J	1.8	76.6	45			28.5	8.4		13.7	31
VPD4-20R[5]-2J	2			10.9	17.5					
VPD4-20R[5]-3J	3									
VPD4-20R[5]-4J[9]	4									
VPD4-20R[5]-6J[9]	6			11.7	18.9					

RoHS Compliant

Copper alloy free available

CAD (2D&3D)

- ※ [5]: Replaced with Pad rubber material code. Refer to page 492 for details.
- ※ [9]: Replaced with "-S3" for -S3 spec. (Copper alloy free material for metal parts and FKM or HNBR for sealing parts). -S3 spec. is available for model codes with 9 in the table above.
- ※ .Pad material N, NE, and G are not suitable for use under ozone environment.
- ※ .Tightening torque of a pad holder fixing bulkhead nut is as below.
•Pad dia. : ø1~ø4mm ▶ 1.8~2.4N·m



Unit : mm

VPD6-3R[5][6][9]

VPD8-3R[5][6][9]

Connection
config. code
-T8

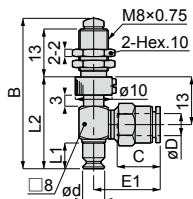

VPD6-3R[5][6][9]

VPD8-3R[5][6][9]

Connection
config. code
-T8

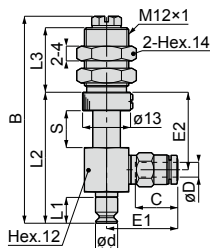

Stroke (mm)
3, 10, 15, 20

Model code	Tube O.D. øD	Pad O.D. ød	B	L1	L2	L3	Tube end C	E1	E2	Stroke S	Spring force (N)				
VPD6-3R[5]-180J	1.8	6	41	7	25	—	8.4	12.7	—	—	—				
VPD6-3R[5]-2J	2						10.9	16.5							
VPD6-3R[5]-3J	3						11.7	18.4							
VPD6-3R[5]-4J[9]	4				35.5	17.5	8.4	14.7				21	10		
VPD6-3R[5]-6J[9]	6						10.9	18.5							
VPD6-10R[5]-180J	1.8						11.7	19.9							
VPD6-10R[5]-2J	2	6	56.1	7	35.5	17.5	8.4	14.7	21	10					
VPD6-10R[5]-3J	3						10.9	18.5							
VPD6-10R[5]-4J	4						11.7	19.9							
VPD6-15R[5]-180J	1.8				6	67.1	7	40.5			23.5	8.4	14.7	26	15
VPD6-15R[5]-2J	2											10.9	18.5		
VPD6-15R[5]-3J	3											11.7	19.9		
VPD6-15R[5]-4J	4	45.5	28.5	8.4				14.7	31	20					
VPD6-15R[5]-6J	6			10.9				18.5							
VPD6-20R[5]-180J	1.8			11.7				19.9							
VPD6-20R[5]-2J	2	6	77.1	7	45.5	28.5	8.4	14.7	31	20					
VPD6-20R[5]-3J	3						10.9	18.5							
VPD6-20R[5]-4J	4						11.7	19.9							
VPD6-20R[5]-6J	6				6	39.5	5.5	23.5			—	8.4	12.7	—	—
VPD8-3R[5]-180J	1.8											10.9	16.5		
VPD8-3R[5]-2J	2											11.7	18.4		
VPD8-3R[5]-3J	3	34	17.5	8.4				14.7	21	10					
VPD8-3R[5]-4J[9]	4			10.9				18.5							
VPD8-3R[5]-6J[9]	6			11.7				19.9							
VPD8-10R[5]-180J	1.8	6	54.6	5.5	34	17.5	8.4	14.7	21	10					
VPD8-10R[5]-2J	2						10.9	18.5							
VPD8-10R[5]-3J	3						11.7	19.9							
VPD8-15R[5]-180J	1.8				6	65.6	5.5	39			23.5	8.4	14.7	26	15
VPD8-15R[5]-2J	2											10.9	18.5		
VPD8-15R[5]-3J	3											11.7	19.9		
VPD8-15R[5]-4J	4	44	28.5	8.4				14.7	31	20					
VPD8-15R[5]-6J	6			10.9				18.5							
VPD8-20R[5]-180J	1.8			11.7				19.9							
VPD8-20R[5]-2J	2	6	75.6	5.5	44	28.5	8.4	14.7	31	20					
VPD8-20R[5]-3J	3						10.9	18.5							
VPD8-20R[5]-4J	4						11.7	19.9							
VPD8-20R[5]-6J	6				11.7	19.9									

RoHS Compliant

Copper alloy free available

CAD (2D&3D)

※ [5]: Replaced with Pad rubber material code. Refer to page 492 for details.

※ [9]: Replaced with "-S3" for -S3 spec. (Copper alloy free material for metal parts and FKM or HNBR for sealing parts). -S3 spec. is available for model codes with 9 in the table above.

※ Pad material N, NE, and G are not suitable for use under ozone environment.

※ Tightening torque of a pad holder fixing bulkhead nut is as below.

•Pad dia. : ø6, ø8mm ▶ 1.8~2.4N·m

※ See Pisco website for weight information.

Unit : mm

VPD10[3]R[5][6][9]
VPD15[3]R(A)[5][6][9]

Connection
config. code
-M4

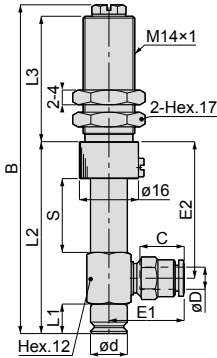

Stroke (mm)
6, 10, 15, 20

RoHS Compliant

Copper alloy free available

CAD (2D&3D)

Model code	Tube O.D. øD	Pad O.D. ød	B	L1	L2	L3	Tube end C	E1	E2	Stroke S	Spring force (N)		
VPD10-6R[5]-3J	3	10	58.1	8	35	20	10.9	18.6	18.5	6	4.0~7.1		
VPD10-6R[5]-4J[9]	4						11.7	19.9					
VPD10-6R[5]-6J[9]	6						11.7	19.9					
VPD10-10R[5]-3J	3				63.1	8	40	20	10.9	18.6	25	10	2.0~5.2
VPD10-10R[5]-4J	4								11.7	19.9			
VPD10-10R[5]-6J	6								11.7	19.9			
VPD10-15R[5]-3J	3		73.1	8			45	25	10.9	18.6	30	15	2.0~5.9
VPD10-15R[5]-4J	4								11.7	19.9			
VPD10-15R[5]-6J	6								11.7	19.9			
VPD10-20R[5]-3J	3				89.1	8	52	34	10.9	18.6	37	20	1.1~4.8
VPD10-20R[5]-4J	4								11.7	19.9			
VPD10-20R[5]-6J	6								11.7	19.9			
VPD15-6R(A)[5]-3J	3	15	58.1(60.1)	9(10)			36(37)	20	10.9	18.6	18.5	6	4.0~7.1
VPD15-6R(A)[5]-4J[9]	4								11.7	19.9			
VPD15-6R(A)[5]-6J[9]	6								11.7	19.9			
VPD15-10R(A)[5]-3J	3				64.1(65.1)	9(10)	41(42)	20	10.9	18.6	25	10	2.0~5.2
VPD15-10R(A)[5]-4J	4								11.7	19.9			
VPD15-10R(A)[5]-6J	6								11.7	19.9			
VPD15-15R(A)[5]-3J	3		74.1(75.1)	9(10)			46(47)	25	10.9	18.6	30	15	2.0~5.9
VPD15-15R(A)[5]-4J	4								11.7	19.9			
VPD15-15R(A)[5]-6J	6								11.7	19.9			
VPD15-20R(A)[5]-3J	3				90.1(91.1)	9(10)	53(54)	34	10.9	18.6	37	20	1.1~4.8
VPD15-20R(A)[5]-4J	4								11.7	19.9			
VPD15-20R(A)[5]-6J	6								11.7	19.9			

※ . Value in () is the dimension of a deep type pad.

※ [5]: Replaced with Pad rubber material code. Refer to page 492 for details.

※ [9]: Replaced with "-S3" for -S3 spec. (Copper alloy free material for metal parts and FKM or HNBR for sealing parts). -S3 spec. is available for model codes with 9 in the table above.

※ . Pad material N, NE, and G are not suitable for use under ozone environment.

※ . Tightening torque of a pad holder fixing bulkhead nut is as below.

• Pad dia. : ø10, ø15mm ▶ 4.5~6N·m

※ . See Pisco website for weight information.



VPD20 3R(A) 5 6 9
 VPD25 3R(A) 5 6 9
 VPD30 3R(A) 5 6 9
 VPD40 3R(A) 5 6 9
 VPD50 3R(A) 5 6 9

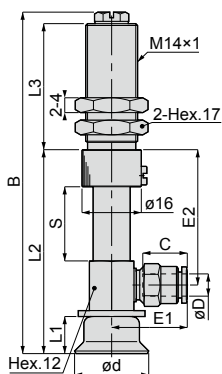

Connection
 config. code
-M6

- RoHS Compliant
- Copper alloy free available
- CAD (2D&3D)

Stroke (mm)
 6, 10, 15, 20

Unit : mm

Model code	Tube O.D. øD	Pad O.D. ød	B	L1	L2	L3	Tube end C	E1	E2	Stroke S	Spring force (N)	
VPD20-6R(A) 5-3J	3	20	60.1(61.1)	10(11)	37(38)	20	10.9	18.6	18.5	6	7.0~12.6	
VPD20-6R(A) 5-4J 9	4						11.7	19.9				
VPD20-6R(A) 5-6J 9	6						11.7	19.9				
VPD20-10R(A) 5-3J	3		66.1(67.1)		43(44)	20	10.9	18.6	24.5	10	3.3~10.0	
VPD20-10R(A) 5-4J	4						11.7	19.9				
VPD20-10R(A) 5-6J	6						11.7	19.9				
VPD20-15R(A) 5-3J	3				76.1(77.1)	48(49)	25	10.9	18.6	29.5	15	3.3~10.4
VPD20-15R(A) 5-4J	4							11.7	19.9			
VPD20-15R(A) 5-6J	6							11.7	19.9			
VPD20-20R(A) 5-3J	3		92.1(93.1)		55(56)	34	10.9	18.6	36.5	20	2.0~8.7	
VPD20-20R(A) 5-4J	4	11.7		19.9								
VPD20-20R(A) 5-6J	6	11.7		19.9								
VPD25-6R(A) 5-3J	3	25	61.1(62.1)	11(12)	38(39)	20	10.9	18.6	18.5	6	7.0~12.6	
VPD25-6R(A) 5-4J 9	4						11.7	19.9				
VPD25-6R(A) 5-6J 9	6						11.7	19.9				
VPD25-10R(A) 5-3J	3		67.1(68.1)		44(45)	20	10.9	18.6	24.5	10	3.3~10.0	
VPD25-10R(A) 5-4J	4						11.7	19.9				
VPD25-10R(A) 5-6J	6						11.7	19.9				
VPD25-15R(A) 5-3J	3				77.1(78.1)	49(50)	25	10.9	18.6	29.5	15	3.3~10.4
VPD25-15R(A) 5-4J	4							11.7	19.9			
VPD25-15R(A) 5-6J	6							11.7	19.9			
VPD25-20R(A) 5-3J	3		93.1(94.1)		56(57)	34	10.9	18.6	36.5	20	2.0~8.7	
VPD25-20R(A) 5-4J	4	11.7		19.9								
VPD25-20R(A) 5-6J	6	11.7		19.9								
VPD30-6R(A) 5-3J	3	30	61.1(64.1)	11(14)	38(41)	20	10.9	18.6	18.5	6	7.0~12.6	
VPD30-6R(A) 5-4J 9	4						11.7	19.9				
VPD30-6R(A) 5-6J 9	6						11.7	19.9				
VPD30-10R(A) 5-3J	3		67.1(70.1)		44(47)	20	10.9	18.6	24.5	10	3.3~10.0	
VPD30-10R(A) 5-4J	4						11.7	19.9				
VPD30-10R(A) 5-6J	6						11.7	19.9				
VPD30-15R(A) 5-3J	3				77.1(80.1)	49(52)	25	10.9	18.6	29.5	15	3.3~10.4
VPD30-15R(A) 5-4J	4							11.7	19.9			
VPD30-15R(A) 5-6J	6							11.7	19.9			
VPD30-20R(A) 5-3J	3		93.1(96.1)		56(59)	34	10.9	18.6	36.5	20	2.0~8.7	
VPD30-20R(A) 5-4J	4	11.7		19.9								
VPD30-20R(A) 5-6J	6	11.7		19.9								

Unit : mm

Model code	Tube O.D. øD	Pad O.D. ød	B	L1	L2	L3	Tube end C	E1	E2	Stroke S	Spring force (N)	
VPD40-6R(A)S-3J	3	40	64.1(67.6)	14(17.5)	41(44.5)	20	10.9	18.6	18.5	6	7.0~12.6	
VPD40-6R(A)S-4J9	4						11.7	19.9				
VPD40-6R(A)S-6J9	6											
VPD40-10R(A)S-3J	3		70.1(73.6)		47(50.5)	20	10.9	18.6	24.5	10	3.3~10.0	
VPD40-10R(A)S-4J	4						11.7	19.9				
VPD40-10R(A)S-6J	6											
VPD40-15R(A)S-3J	3				80.1(83.6)	52(55.5)	25	10.9	18.6	29.5	15	3.3~10.4
VPD40-15R(A)S-4J	4							11.7	19.9			
VPD40-15R(A)S-6J	6											
VPD40-20R(A)S-3J	3		96.1(99.6)		59(62.5)	34	10.9	18.6	36.5	20	2.0~8.7	
VPD40-20R(A)S-4J	4						11.7	19.9				
VPD40-20R(A)S-6J	6											
VPD50-6R(A)S-3J	3	50		65.1(68.1)	15(18)	42(45)	20	10.9	18.6	18.5	6	7.0~12.6
VPD50-6R(A)S-4J9	4							11.7	19.9			
VPD50-6R(A)S-6J9	6											
VPD50-10R(A)S-3J	3		71.1(74.1)	48(51)		20	10.9	18.6	24.5	10	3.3~10.0	
VPD50-10R(A)S-4J	4						11.7	19.9				
VPD50-10R(A)S-6J	6											
VPD50-15R(A)S-3J	3			81.1(84.1)		53(56)	25	10.9	18.6	29.5	15	3.3~10.4
VPD50-15R(A)S-4J	4							11.7	19.9			
VPD50-15R(A)S-6J	6											
VPD50-20R(A)S-3J	3		97.1(100.1)	60(63)		34	10.9	18.6	36.5	20	2.0~8.7	
VPD50-20R(A)S-4J	4						11.7	19.9				
VPD50-20R(A)S-6J	6											

※ .Value in () is the dimension of a deep type pad.

※ .S: Replaced with Pad rubber material code. Refer to page 492 for details.

※ .9: Replaced with "-S3" for -S3 spec. (Copper alloy free material for metal parts and FKM or HNBR for sealing parts). -S3 spec. is available for model codes with 9 in the table above.

※ .Pad material N, NE, and G are not suitable for use under ozone environment.

※ .Tightening torque of a pad holder fixing bulkhead nut is as below.

•Pad dia. : ø20~ø50mm ▶ 4.5~6N·m

※ .See Pisco website for weight information.



VPD60-10R(A) [5][6]
VPD80-10R(A) [5][6]
VPD100-10R(A) [5][6]
VPD150-20R [5][6]
VPD200-20R [5][6]

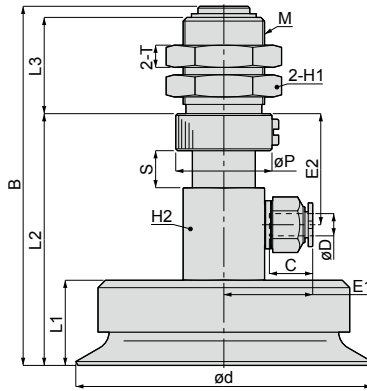

Connection
config. code
-M10

Connection
config. code
-M20

RoHS Compliant

Copper alloy free available

CAD (2D&3D)

Stroke (mm)
10, 20

Unit : mm

Model code	Tube O.D. øD	Pad O.D. ød	Thread M	B	L1	L2	L3	øP	Tube end C	E1	E2	Hex. H1	Hex. H2	T	Stroke S	Spring force (N)
VPD60-10R(A)[5]-4J	4	60	M22×1	94.6(101.6)	18(25)	65.6(72.6)	26	26	10.9	21.6	30	27	22	6	10	10.1~15.8
VPD60-10R(A)[5]-6J	6								11.7	23.9						
VPD60-10R(A)[5]-8J	8								18.2	32.5						
VPD80-10R(A)[5]-4J	4	80	M22×1	97(107)	23(33)	68(78)	26	26	10.9	21.6	30	27	22	6	10	10.1~15.8
VPD80-10R(A)[5]-6J	6								11.7	23.9						
VPD80-10R(A)[5]-8J	8								18.2	32.5						
VPD100-10R(A)[5]-4J	4	100	M22×1	99(108)	25(34)	70(79)	26	26	10.9	21.6	30	27	22	6	10	10.1~15.8
VPD100-10R(A)[5]-6J	6								11.7	23.9						
VPD100-10R(A)[5]-8J	8								18.2	32.5						
VPD150-20R[5]-6J	6	150	M30×2	168.3	45	112.1	48	35	17	31.3	42.1	36	30	10	20.1	14.0~25.5
VPD150-20R[5]-8J	8								18.2	32						
VPD150-20R[5]-10J	10								20.7	39						
VPD200-20R[5]-6J	6	200	M30×2	173.3	50	117.1	48	35	17	31.3	42.1	36	30	10	20.1	14.0~25.5
VPD200-20R[5]-8J	8								18.2	32						
VPD200-20R[5]-10J	10								20.7	39						

※. Value in () is the dimension of a deep type pad.

※. [5]: Replaced with Pad rubber material code. Refer to page 492 for details.

※. Pad material N, NE, and G are not suitable for use under ozone environment.

※. Tightening torque of a pad holder fixing bulkhead nut is as below.

•Pad dia. : ø60~ø100mm ▶ 16~20N·m, •Pad dia. : ø150, ø200mm ▶ 42~54N·m

※. See Pisco website for weight information.

VPD Spring type / Side port / Barb fitting / Standard holder

Unit : mm

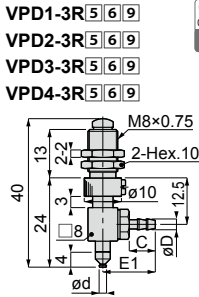

Connection
config. code
-H3

Model code	Tube I.D. øD	Pad O.D. ød	B	L2	L3	C	E1	E2	Stroke S	Spring force (N)							
VPD1-3R[5]-3B[9]	2	1	—	—	—	6	12.4	—	3	0.9~1.9							
VPD1-3R[5]-4B[9]	2.5					7	13.9										
VPD1-3R[5]-6B[9]	4					7	14.9										
VPD1-10R[5]-3B	2		55.6	35	17.5	6	13.4	21	10	0.6~1.7							
VPD1-10R[5]-4B	2.5					7	14.9										
VPD1-10R[5]-6B	4					6	13.4										
VPD1-15R[5]-3B	2					66.6	40				23.5	7	14.9	26	15	0.4~1.7	
VPD1-15R[5]-4B	2.5											6	13.4				
VPD1-15R[5]-6B	4											7	14.9				
VPD1-20R[5]-3B	2		76.6	45	28.5	6	13.4	31	20	0.3~1.8							
VPD1-20R[5]-4B	2.5					7	14.9										
VPD1-20R[5]-6B	4					6	12.4										
VPD2-3R[5]-3B[9]	2	2				—	—				6	12.4	—	3	0.9~1.9		
VPD2-3R[5]-4B[9]	2.5															7	13.9
VPD2-3R[5]-6B[9]	4															7	14.9
VPD2-10R[5]-3B	2		55.6	35	17.5	6	13.4	21	10	0.6~1.7							
VPD2-10R[5]-4B	2.5					7	14.9										
VPD2-10R[5]-6B	4					6	13.4										
VPD2-15R[5]-3B	2					66.6	40				23.5	7	14.9	26	15	0.4~1.7	
VPD2-15R[5]-4B	2.5											6	13.4				
VPD2-15R[5]-6B	4											7	14.9				
VPD2-20R[5]-3B	2		76.6	45	28.5	6	13.4	31	20	0.3~1.8							
VPD2-20R[5]-4B	2.5					7	14.9										
VPD2-20R[5]-6B	4					6	12.4										
VPD3-3R[5]-3B[9]	2	3				—	—				6	12.4	—	3	0.9~1.9		
VPD3-3R[5]-4B[9]	2.5															7	13.9
VPD3-3R[5]-6B[9]	4															7	14.9
VPD3-10R[5]-3B	2		55.6	35	17.5	6	13.4	21	10	0.6~1.7							
VPD3-10R[5]-4B	2.5					7	14.9										
VPD3-10R[5]-6B	4					6	13.4										
VPD3-15R[5]-3B	2					66.6	40				23.5	7	14.9	26	15	0.4~1.7	
VPD3-15R[5]-4B	2.5											6	13.4				
VPD3-15R[5]-6B	4											7	14.9				
VPD3-20R[5]-3B	2		76.6	45	28.5	6	13.4	31	20	0.3~1.8							
VPD3-20R[5]-4B	2.5					7	14.9										
VPD3-20R[5]-6B	4					6	12.4										
VPD4-3R[5]-3B[9]	2	4				—	—				6	12.4	—	3	0.9~1.9		
VPD4-3R[5]-4B[9]	2.5															7	13.9
VPD4-3R[5]-6B[9]	4															7	14.9
VPD4-10R[5]-3B	2		55.6	35	17.5	6	13.4	21	10	0.6~1.7							
VPD4-10R[5]-4B	2.5					7	14.9										
VPD4-10R[5]-6B	4					6	13.4										
VPD4-15R[5]-3B	2					66.6	40				23.5	7	14.9	26	15	0.4~1.7	
VPD4-15R[5]-4B	2.5											6	13.4				
VPD4-15R[5]-6B	4											7	14.9				
VPD4-20R[5]-3B	2		76.6	45	28.5	6	13.4	31	20	0.3~1.8							
VPD4-20R[5]-4B	2.5					7	14.9										
VPD4-20R[5]-6B	4					6	12.4										

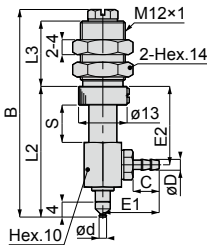

Connection
config. code
-H3

Stroke (mm)
3, 10, 15, 20

- RoHS Compliant
- Copper alloy free available
- CAD (2D&3D)

Unit : mm

VPD6-3R[5][6][9]

VPD8-3R[5][6][9]

Connection
config. code
-T8

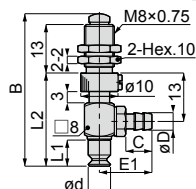

VPD6[3]R[5][6][9]

VPD8[3]R[5][6][9]

Connection
config. code
-T8

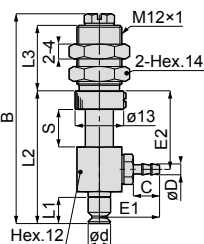

VPD10[3]R[5][6][9]

VPD15[3]R(A)[5][6][9]

Connection
config. code
-M4

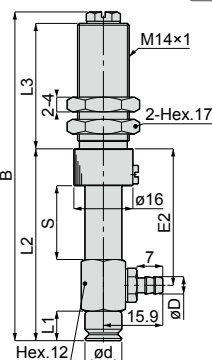

Stroke (mm)
3, 10, 15, 20

Model code	Tube I.D. øD	Pad O.D. ød	B	L1	L2	L3	C	E1	E2	Stroke S	Spring force (N)							
VPD6-3R[5]-3B[9]	2	6	41	7	25	—	6	12.4	—	3	0.9~1.9							
VPD6-3R[5]-4B[9]	2.5						7	13.9										
VPD6-3R[5]-6B[9]	4						7	13.9										
VPD6-10R[5]-3B	2						6	14.4				21	10	0.8~2.7				
VPD6-10R[5]-4B	2.5						7	15.9										
VPD6-10R[5]-6B	4						7	15.9										
VPD6-15R[5]-3B	2	6	14.4	26	15	0.7~3.0												
VPD6-15R[5]-4B	2.5	7	15.9															
VPD6-15R[5]-6B	4	7	15.9															
VPD6-20R[5]-3B	2	6	14.4				31	20	0.9~3.4									
VPD6-20R[5]-4B	2.5	7	15.9															
VPD6-20R[5]-6B	4	7	15.9															
VPD8-3R[5]-3B[9]	2	8	39.5	5.5	23.5	—				6	12.4	—	3	0.9~1.9				
VPD8-3R[5]-4B[9]	2.5									7	13.9							
VPD8-3R[5]-6B[9]	4									7	13.9							
VPD8-10R[5]-3B	2						6	14.4	21	10	0.8~2.7							
VPD8-10R[5]-4B	2.5						7	15.9										
VPD8-10R[5]-6B	4						7	15.9										
VPD8-15R[5]-3B	2	6	14.4	26	15	0.7~3.0												
VPD8-15R[5]-4B	2.5	7	15.9															
VPD8-15R[5]-6B	4	7	15.9															
VPD8-20R[5]-3B	2	6	14.4				31	20	0.9~3.4									
VPD8-20R[5]-4B	2.5	7	15.9															
VPD8-20R[5]-6B	4	7	15.9															
VPD10-6R[5]-4B[9]	2.5	10	58.1	8	35	20				—	—	18.5	6	4.0~7.1				
VPD10-6R[5]-6B[9]	4											25	10	2.0~5.2				
VPD10-10R[5]-4B	2.5											63.1	40	30	15	2.0~5.9		
VPD10-10R[5]-6B	4						73.1	45	25			37	20	1.1~4.8				
VPD10-15R[5]-4B	2.5						15	89.1	9(10)			52	34	—	—	30	15	2.0~5.9
VPD10-15R[5]-6B	4															37	20	1.1~4.8
VPD15-6R(A)[5]-4B[9]	2.5	59.1(60.1)	36(37)	20	18.5	6				4.0~7.1								
VPD15-6R(A)[5]-6B[9]	4	64.1(65.1)	41(42)	—	25	10				2.0~5.2								
VPD15-10R(A)[5]-4B	2.5	74.1(75.1)	46(47)	25	30	15				2.0~5.9								
VPD15-15R(A)[5]-6B	4	80.1(81.1)	53(54)	34	37	20				1.1~4.8								

※ .Value in () is the dimension of a deep type pad.

※ .[5]: Replaced with Pad rubber material code. Refer to page 492 for details.

※ .[9]: Replaced with "-S3" for -S3 spec. (Copper alloy free material for metal parts and FKM or HNBR for sealing parts). -S3 spec. is available for model codes with 9 in the table above.

※ Pad material N, NE, and G are not suitable for use under ozone environment.

※ Tightening torque of a pad holder fixing bulkhead nut is as below.

•Pad dia. : ø6, ø8mm ▶ 1.8~2.4N·m, •Pad dia. : ø10, ø15mm ▶ 4.5~6N·m

※ See Pisco website for weight information.

RoHS Compliant

Copper alloy free available

CAD (2D&3D)

Unit : mm

VPD20 ³ ^R(A) ⁵ ⁶ ⁹
VPD25 ³ ^R(A) ⁵ ⁶ ⁹
VPD30 ³ ^R(A) ⁵ ⁶ ⁹
VPD40 ³ ^R(A) ⁵ ⁶ ⁹
VPD50 ³ ^R(A) ⁵ ⁶ ⁹

Connection
config. code
-M6

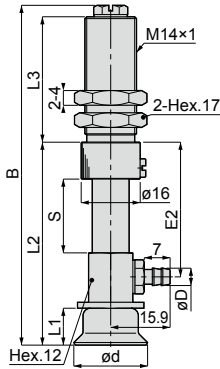

Stroke (mm)
6, 10, 15, 20



RoHS Compliant

Copper alloy free available

CAD (2D&3D)

Model code	Tube I.D. øD	Pad O.D. ød	B	L1	L2	L3	E2	Stroke S	Spring force (N)		
VPD20-6R(A) ⁵ ⁶ ⁹	2.5	20	60.1(61.1)	10(11)	37(38)	20	18.5	6	7.0~12.6		
VPD20-6R(A) ⁵ ⁶ ⁹	4										
VPD20-10R(A) ⁵ ⁶ ⁹	2.5										
VPD20-10R(A) ⁵ ⁶ ⁹	4		43(44)		25	29.5	10	3.3~10.0			
VPD20-15R(A) ⁵ ⁶ ⁹	2.5										
VPD20-15R(A) ⁵ ⁶ ⁹	4										
VPD20-20R(A) ⁵ ⁶ ⁹	2.5	25	76.1(77.1)	11(12)	48(49)	34	36.5	20	2.0~8.7		
VPD20-20R(A) ⁵ ⁶ ⁹	4										
VPD25-6R(A) ⁵ ⁶ ⁹	2.5										
VPD25-6R(A) ⁵ ⁶ ⁹	4		61.1(62.1)		20	38(39)	18.5	6		7.0~12.6	
VPD25-10R(A) ⁵ ⁶ ⁹	2.5										
VPD25-10R(A) ⁵ ⁶ ⁹	4										
VPD25-15R(A) ⁵ ⁶ ⁹	2.5	67.1(68.1)	25	44(45)		24.5	10	3.3~10.0			
VPD25-15R(A) ⁵ ⁶ ⁹	4										
VPD25-20R(A) ⁵ ⁶ ⁹	2.5										
VPD25-20R(A) ⁵ ⁶ ⁹	4	77.1(78.1)		34	49(50)	29.5	15		3.3~10.4		
VPD30-6R(A) ⁵ ⁶ ⁹	2.5										
VPD30-6R(A) ⁵ ⁶ ⁹	4										
VPD30-10R(A) ⁵ ⁶ ⁹	2.5	30	61.1(64.1)		11(14)	38(41)	20	18.5		6	7.0~12.6
VPD30-10R(A) ⁵ ⁶ ⁹	4										
VPD30-15R(A) ⁵ ⁶ ⁹	2.5										
VPD30-15R(A) ⁵ ⁶ ⁹	4		67.1(70.1)	25		44(47)	24.5	10	3.3~10.0		
VPD30-20R(A) ⁵ ⁶ ⁹	2.5										
VPD30-20R(A) ⁵ ⁶ ⁹	4										
VPD30-20R(A) ⁵ ⁶ ⁹	2.5	40	77.1(80.1)		14(17.5)	49(52)	29.5	15		3.3~10.4	
VPD30-20R(A) ⁵ ⁶ ⁹	4										
VPD40-6R(A) ⁵ ⁶ ⁹	2.5										
VPD40-6R(A) ⁵ ⁶ ⁹	4		64.1(67.6)	20		41(44.5)	18.5	6	7.0~12.6		
VPD40-10R(A) ⁵ ⁶ ⁹	2.5										
VPD40-10R(A) ⁵ ⁶ ⁹	4										
VPD40-15R(A) ⁵ ⁶ ⁹	2.5	70.1(73.6)			25	47(50.5)	24.5	10		3.3~10.0	
VPD40-15R(A) ⁵ ⁶ ⁹	4										
VPD40-20R(A) ⁵ ⁶ ⁹	2.5										
VPD40-20R(A) ⁵ ⁶ ⁹	4	80.1(83.6)	34	52(55.5)		29.5	15	3.3~10.4			
VPD50-6R(A) ⁵ ⁶ ⁹	2.5										
VPD50-6R(A) ⁵ ⁶ ⁹	4										
VPD50-10R(A) ⁵ ⁶ ⁹	2.5			65.1(68.1)	15(18)	42(45)	18.5		6	7.0~12.6	
VPD50-10R(A) ⁵ ⁶ ⁹	4										
VPD50-15R(A) ⁵ ⁶ ⁹	2.5										
VPD50-15R(A) ⁵ ⁶ ⁹	4	71.1(74.1)	20			48(51)	24.5	10	3.3~10.0		
VPD50-20R(A) ⁵ ⁶ ⁹	2.5										
VPD50-20R(A) ⁵ ⁶ ⁹	4										
VPD50-20R(A) ⁵ ⁶ ⁹	2.5	81.1(84.1)		34	53(56)	29.5	15	3.3~10.4			
VPD50-20R(A) ⁵ ⁶ ⁹	4										
VPD50-20R(A) ⁵ ⁶ ⁹	2.5										
VPD50-20R(A) ⁵ ⁶ ⁹	4	97.1(100.1)	20		60(63)	36.5	20		2.0~8.7		

※ .Value in () is the dimension of a deep type pad.

※ ⁵ : Replaced with Pad rubber material code. Refer to page 492 for details.

※ ⁹ : Replaced with "-S3" for -S3 spec. (Copper alloy free material for metal parts and FKM or HNBR for sealing parts). -S3 spec. is available for model codes with 9 in the table above.

※ Pad material N, NE, and G are not suitable for use under ozone environment.

※ Tightening torque of a pad holder fixing bulkhead nut is as below.

▶ Pad dia. : ø20~ø50mm ▶ 4.5~6N·m

※ See Pisco website for weight information.



VPD Spring type / Side port / Female thread / Standard holder

VPD1-3R[5]-M5[9]

VPD2-3R[5]-M5[9]

VPD3-3R[5]-M5[9]

VPD4-3R[5]-M5[9]

VPD1[3]R[5]-M5

VPD2[3]R[5]-M5

VPD3[3]R[5]-M5

VPD4[3]R[5]-M5

VPD6-3R[5]-M5[9]

VPD8-3R[5]-M5[9]

VPD6[3]R[5]-M5

VPD8[3]R[5]-M5

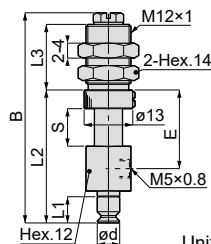
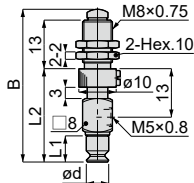
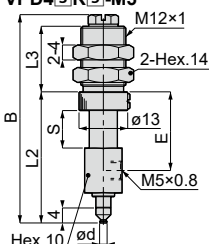
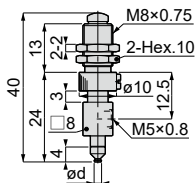

Unit : mm

Model code	Pad O.D. ød	B	L1	L2	L3	E	Stroke S	Spring force (N)	Connection config. code	
VPD1-3R[5]-M5[9]	1	—	—	—	—	—	—	0.9~1.9	-H3	
VPD1-10R[5]-M5		55.6	—	35	17.5	21	10	0.6~1.7		
VPD1-15R[5]-M5		66.6	—	40	23.5	26	15	0.4~1.7		
VPD1-20R[5]-M5		76.6	—	45	28.5	31	20	0.3~1.8		
VPD2-3R[5]-M5[9]	2	—	—	—	—	—	—	0.9~1.9		
VPD2-10R[5]-M5		55.6	—	35	17.5	21	10	0.6~1.7		
VPD2-15R[5]-M5		66.6	—	40	23.5	26	15	0.4~1.7		
VPD2-20R[5]-M5		76.6	—	45	28.5	31	20	0.3~1.8		
VPD3-3R[5]-M5[9]	3	—	—	—	—	—	—	0.9~1.9		
VPD3-10R[5]-M5		55.6	—	35	17.5	21	10	0.6~1.7		
VPD3-15R[5]-M5		66.6	—	40	23.5	26	15	0.4~1.7		
VPD3-20R[5]-M5		76.6	—	45	28.5	31	20	0.3~1.8		
VPD4-3R[5]-M5[9]	4	—	—	—	—	—	—	0.9~1.9		
VPD4-10R[5]-M5		55.6	—	35	17.5	21	10	0.6~1.7		
VPD4-15R[5]-M5		66.6	—	40	23.5	26	15	0.4~1.7		
VPD4-20R[5]-M5		76.6	—	45	28.5	31	20	0.3~1.8		
VPD6-3R[5]-M5[9]	6	41	7	25	—	—	—	0.9~1.9	-T8	
VPD6-10R[5]-M5		56.1		35.5	17.5	21	10	0.8~2.7		
VPD6-15R[5]-M5		67.1		40.5	23.5	26	15	0.7~3.0		
VPD6-20R[5]-M5		77.1		45.5	28.5	31	20	0.9~3.4		
VPD8-3R[5]-M5[9]	8	39.5	5.5	23.5	—	—	—	0.9~1.9		
VPD8-10R[5]-M5		54.6		34	17.5	21	10	0.8~2.7		
VPD8-15R[5]-M5		65.6		39	23.5	26	15	0.7~3.0		
VPD8-20R[5]-M5		75.6		44	28.5	31	20	0.9~3.4		
VPD10-6R[5]-M6[9]	10	58.1	8	35	20	18.5	6	4.0~7.1		-M4
VPD10-10R[5]-M6		63.1		40		25	10	2.0~5.2		
VPD10-15R[5]-M6		73.1		45	25	30	15	2.0~5.9		
VPD10-20R[5]-M6		89.1		52	34	37	20	1.1~4.8		
VPD15-6R(A)[5]-M6[9]	15	59.1(60.1)	9(10)	36(37)	20	18.5	6	4.0~7.1		
VPD15-10R(A)[5]-M6		64.1(65.1)		41(42)		25	10	2.0~5.2		
VPD15-15R(A)[5]-M6		74.1(75.1)		46(47)	25	30	15	2.0~5.9		
VPD15-20R(A)[5]-M6		90.1(91.1)		53(54)	34	37	20	1.1~4.8		

※ Value in () is the dimension of a deep type pad.

※ [5]: Replaced with Pad rubber material code. Refer to page 492 for details.

※ [9]: Replaced with "S3" for -S3 spec. (Copper alloy free material for metal parts and FKM or HNBR for sealing parts). -S3 spec. is available for model codes with 9 in the table above.

※ See Pisco website for weight information.

Stroke (mm)
3, 6, 10, 15, 20

RoHS Compliant ~~Copper alloy free available~~ CAD (2D&3D)

VPD10[R(A)]S-M6[9]
VPD15[R(A)]S-M6[9]

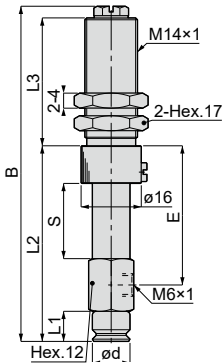

VPD20[R(A)]S-M6[9]
VPD25[R(A)]S-M6[9]
VPD30[R(A)]S-M6[9]
VPD40[R(A)]S-M6[9]
VPD50[R(A)]S-M6[9]

Connection
config. code
-M6

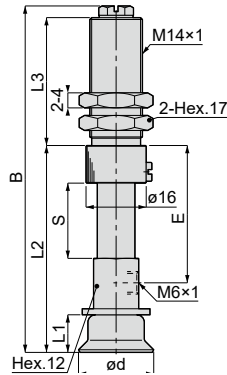

VPD60-10R(A)S-G1[9]
VPD80-10R(A)S-G1[9]
VPD100-10R(A)S-G1[9]
VPD150-20R(S)S-G2[9]
VPD200-20R(S)S-G2[9]

Connection
config. code
-M10

Connection
config. code
-M20

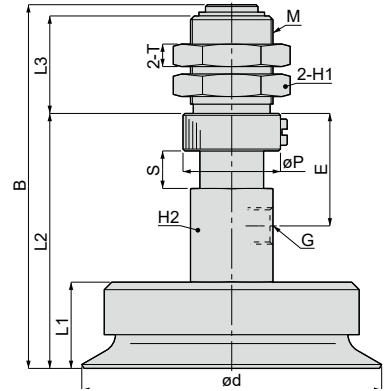

Unit : mm

Model code	Port size G	Pad O.D. Ød	Thread M	B	L1	L2	L3	ØP	E	Hex. H1	Hex. H2	T	Stroke S	Spring force (N)
VPD20-6R(A)S-M6[9]	—	20	—	60.1(61.1)	10(11)	37(38)	20	—	18.5	—	—	—	6	7.0~12.6
VPD20-10R(A)S-M6	66.1(67.1)			43(44)		24.5			10				3.3~10.0	
VPD20-15R(A)S-M6	76.1(77.1)			48(49)		25	29.5		15				3.3~10.4	
VPD20-20R(A)S-M6	92.1(93.1)			55(56)		34	36.5		20				2.0~8.7	
VPD25-6R(A)S-M6[9]	—	25	—	61.1(62.1)	11(12)	38(39)	20	—	18.5	—	—	—	6	7.0~12.6
VPD25-10R(A)S-M6				67.1(68.1)		44(45)			24.5				10	3.3~10.0
VPD25-15R(A)S-M6				77.1(78.1)		49(50)	25		29.5				15	3.3~10.4
VPD25-20R(A)S-M6				93.1(94.1)		56(57)	34		36.5				20	2.0~8.7
VPD30-6R(A)S-M6[9]	—	30	—	61.1(64.1)	11(14)	38(41)	20	—	18.5	—	—	—	6	7.0~12.6
VPD30-10R(A)S-M6				67.1(70.1)		44(47)			24.5				10	3.3~10.0
VPD30-15R(A)S-M6				77.1(80.1)		49(52)	25		29.5				15	3.3~10.4
VPD30-20R(A)S-M6				93.1(96.1)		56(59)	34		36.5				20	2.0~8.7
VPD40-6R(A)S-M6[9]	—	40	—	64.1(67.6)	14(17.5)	41(44.5)	20	—	18.5	—	—	—	6	7.0~12.6
VPD40-10R(A)S-M6				70.1(73.8)		47(50.5)			24.5				10	3.3~10.0
VPD40-15R(A)S-M6				80.1(83.6)		52(55.5)	25		29.5				15	3.3~10.4
VPD40-20R(A)S-M6				96.1(99.6)		59(62.5)	34		36.5				20	2.0~8.7
VPD50-6R(A)S-M6[9]	—	50	—	65.1(68.1)	15(18)	42(45)	20	—	18.5	—	—	—	6	7.0~12.6
VPD50-10R(A)S-M6				71.1(74.1)		48(51)			24.5				10	3.3~10.0
VPD50-15R(A)S-M6				81.1(84.1)		53(56)	25		29.5				15	3.3~10.4
VPD50-20R(A)S-M6				97.1(100.1)		60(63)	34		36.5				20	2.0~8.7
VPD60-10R(A)S-G1[9]	G1/8	60	M22×1	94.6(101.6)	18(25)	65.6(72.6)	26	26	30	27	22	6	10	10.1~15.8
VPD80-10R(A)S-G1[9]	G1/8	80	M22×1	97(107)	23(33)	68(78)	26	26	30	27	22	6	10	10.1~15.8
VPD100-10R(A)S-G1[9]	G1/8	100	M22×1	99(108)	25(34)	70(79)	26	26	30	27	22	6	10	10.1~15.8
VPD150-20R(S)S-G2[9]	G1/4	150	M30×2	168.3	45	112.1	48	35	42.1	36	30	10	20.1	14.0~25.5
VPD200-20R(S)S-G2[9]	G1/4	200	M30×2	173.3	50	117.1	48	35	42.1	36	30	10	20.1	14.0~25.5

※. Pad material N, NE, and G are not suitable for use under ozone environment.

※. Tightening torque of a pad holder fixing bulkhead nut is as below.

•Pad dia. : ø1~ø8mm ▶ 1.8~2.4N·m, •Pad dia. : ø10~ø50mm ▶ 4.5~6N·m, •Pad dia. : ø60~ø100mm ▶ 16~20N·m,

•Pad dia. : ø150, ø200mm ▶ 42~54N·m



VPOD Spring type / Side port / Push-in fitting / No cover holder



VPOD20 $\frac{3}{8}$ R(A) $\frac{5}{16}$
 VPOD25 $\frac{3}{8}$ R(A) $\frac{5}{16}$
 VPOD30 $\frac{3}{8}$ R(A) $\frac{5}{16}$

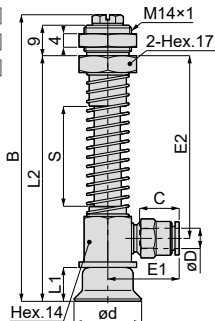

Connection
config. code
-M6

RoHS Compliant CAD (2D&3D)

Stroke (mm)
20,30,40,50

Unit : mm

Model code	Tube O.D. øD	Pad O.D. ød	B	L1	L2	Tube end C	E1	E2	Stroke S	Spring force (N)						
VPOD20-20R(A) $\frac{3}{8}$ -3J	3	20	71.6(72.6)	10(11)	59.5(60.5)	10.9	19.6	41	20	1.5~4.9						
VPOD20-20R(A) $\frac{3}{8}$ -4J	4					11.7	20.9									
VPOD20-20R(A) $\frac{5}{16}$ -6J	6		84.6(85.6)		72.5(73.5)	10.9	19.6	54	30		1.1~4.8					
VPOD20-30R(A) $\frac{3}{8}$ -3J	3					11.7	20.9									
VPOD20-30R(A) $\frac{3}{8}$ -4J	4		97.6(98.6)		85.5(86.5)	10.9	19.6	67	40		1.0~4.5					
VPOD20-30R(A) $\frac{5}{16}$ -6J	6					11.7	20.9									
VPOD20-40R(A) $\frac{3}{8}$ -3J	3		25		72.6(73.6)	11(12)	60.5(61.5)	10.9	19.6		41	1.5~4.9				
VPOD20-40R(A) $\frac{3}{8}$ -4J	4							11.7	20.9							
VPOD20-40R(A) $\frac{5}{16}$ -6J	6				85.6(86.6)		73.5(74.5)	10.9	19.6		54		30	1.1~4.8		
VPOD20-50R(A) $\frac{3}{8}$ -3J	3							11.7	20.9							
VPOD20-50R(A) $\frac{3}{8}$ -4J	4	98.6(99.6)		86.5(87.5)	10.9		19.6	67	40	1.0~4.5						
VPOD20-50R(A) $\frac{5}{16}$ -6J	6				11.7		20.9									
VPOD20-50R(A) $\frac{3}{8}$ -3J	3	30	110.6(111.6)	11(14)	98.5(99.5)	10.9	19.6	80	0.9~4.5							
VPOD20-50R(A) $\frac{3}{8}$ -4J	4					11.7	20.9									
VPOD25-20R(A) $\frac{3}{8}$ -3J	3		25		72.6(73.6)	11(12)	60.5(61.5)	10.9		19.6	41	1.5~4.9				
VPOD25-20R(A) $\frac{3}{8}$ -4J	4							11.7		20.9						
VPOD25-20R(A) $\frac{5}{16}$ -6J	6				85.6(86.6)		73.5(74.5)	10.9		19.6	54		30	1.1~4.8		
VPOD25-30R(A) $\frac{3}{8}$ -3J	3							11.7		20.9						
VPOD25-30R(A) $\frac{3}{8}$ -4J	4	98.6(99.6)		86.5(87.5)	10.9		19.6	67	40	1.0~4.5						
VPOD25-30R(A) $\frac{5}{16}$ -6J	6				11.7		20.9									
VPOD25-40R(A) $\frac{3}{8}$ -3J	3	30		111.6(112.6)	11(14)	99.5(100.5)	10.9	19.6	80	0.9~4.5						
VPOD25-40R(A) $\frac{3}{8}$ -4J	4						11.7	20.9								
VPOD25-50R(A) $\frac{3}{8}$ -3J	3			30		72.6(75.6)	11(14)	60.5(63.5)	10.9		19.6		41	1.5~4.9		
VPOD25-50R(A) $\frac{3}{8}$ -4J	4								11.7		20.9					
VPOD30-20R(A) $\frac{3}{8}$ -3J	3		85.6(88.6)			73.5(76.5)		10.9	19.6		54	30	1.1~4.8			
VPOD30-20R(A) $\frac{3}{8}$ -4J	4							11.7	20.9							
VPOD30-30R(A) $\frac{3}{8}$ -3J	3	98.6(101.6)	86.5(89.5)		10.9	19.6		67	40	1.0~4.5						
VPOD30-30R(A) $\frac{3}{8}$ -4J	4				11.7	20.9										
VPOD30-40R(A) $\frac{3}{8}$ -3J	3	30	111.6(114.6)		11(14)	99.5(102.5)	10.9	19.6	80	0.9~4.5						
VPOD30-40R(A) $\frac{3}{8}$ -4J	4						11.7	20.9								
VPOD30-50R(A) $\frac{3}{8}$ -3J	3		111.6(114.6)			99.5(102.5)	10.9	19.6	80		50	0.9~4.5				
VPOD30-50R(A) $\frac{3}{8}$ -4J	4						11.7	20.9								
VPOD30-50R(A) $\frac{5}{16}$ -6J	6															
VPOD30-50R(A) $\frac{3}{8}$ -3J	3															

Unit : mm

Model code	Tube O.D. øD	Pad O.D. ød	B	L1	L2	Tube end C	E1	E2	Stroke S	Spring force (N)
VPOD40-20R(A) [5]-3J	3	40	75.6(79.1)	14(17.5)	63.5(67)	10.9	19.6	41	20	1.5~4.9
VPOD40-20R(A) [5]-4J	4					11.7	20.9			
VPOD40-20R(A) [5]-6J	6					11.7	20.9			
VPOD40-30R(A) [5]-3J	3		88.6(92.1)		76.5(80)	10.9	19.6	54	30	1.1~4.8
VPOD40-30R(A) [5]-4J	4					11.7	20.9			
VPOD40-30R(A) [5]-6J	6					11.7	20.9			
VPOD40-40R(A) [5]-3J	3		101.6(105.1)		89.5(93)	10.9	19.6	67	40	1.0~4.5
VPOD40-40R(A) [5]-4J	4					11.7	20.9			
VPOD40-40R(A) [5]-6J	6					11.7	20.9			
VPOD40-50R(A) [5]-3J	3		114.6(118.1)		102.5(106)	10.9	19.6	80	50	0.9~4.5
VPOD40-50R(A) [5]-4J	4					11.7	20.9			
VPOD40-50R(A) [5]-6J	6					11.7	20.9			
VPOD50-20R(A) [5]-3J	3	50	76.6(79.6)	15(18)	64.5(67.5)	10.9	19.6	41	20	1.5~4.9
VPOD50-20R(A) [5]-4J	4					11.7	20.9			
VPOD50-20R(A) [5]-6J	6					11.7	20.9			
VPOD50-30R(A) [5]-3J	3		89.6(92.6)		77.5(80.5)	10.9	19.6	54	30	1.1~4.8
VPOD50-30R(A) [5]-4J	4					11.7	20.9			
VPOD50-30R(A) [5]-6J	6					11.7	20.9			
VPOD50-40R(A) [5]-3J	3		102.6(105.6)		90.5(93.5)	10.9	19.6	67	40	1.0~4.5
VPOD50-40R(A) [5]-4J	4					11.7	20.9			
VPOD50-40R(A) [5]-6J	6					11.7	20.9			
VPOD50-50R(A) [5]-3J	3		115.6(118.6)		103.5(106.5)	10.9	19.6	80	50	0.9~4.5
VPOD50-50R(A) [5]-4J	4					11.7	20.9			
VPOD50-50R(A) [5]-6J	6					11.7	20.9			

※ .Value in () is the dimension of a deep type pad.

※ [5]: Replaced with Pad rubber material code. Refer to page 820 for details.

※ .Tightening torque of a pad holder fixing bulkhead nut is 4.5~6N·m.

※ .See Pisco website for weight information.



VPOD Spring type / Side port / Barb fitting / No cover holder

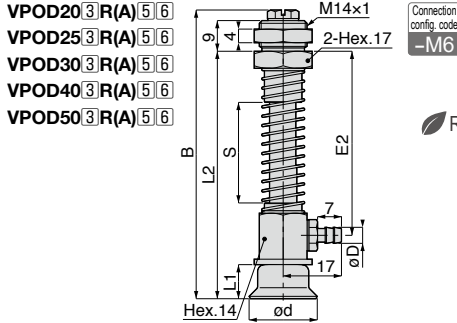

Unit : mm

Model code	Tube I.D. øD	Pad O.D. ød	B	L1	L2	E2	Stroke S	Spring force (N)
VPOD20-20R(A) $\frac{3}{8}$ -4B	2.5	20	71.6(72.6)	10(11)	59.5(60.5)	41	20	1.5 ~ 4.9
VPOD20-20R(A) $\frac{3}{8}$ -6B	4							
VPOD20-30R(A) $\frac{3}{8}$ -4B	2.5							
VPOD20-30R(A) $\frac{3}{8}$ -6B	4							
VPOD20-40R(A) $\frac{3}{8}$ -4B	2.5							
VPOD20-40R(A) $\frac{3}{8}$ -6B	4							
VPOD20-50R(A) $\frac{3}{8}$ -4B	2.5	25	72.6(73.6)	11(12)	60.5(61.5)	41	20	1.5 ~ 4.9
VPOD20-50R(A) $\frac{3}{8}$ -6B	4							
VPOD25-20R(A) $\frac{3}{8}$ -4B	2.5							
VPOD25-20R(A) $\frac{3}{8}$ -6B	4							
VPOD25-30R(A) $\frac{3}{8}$ -4B	2.5							
VPOD25-30R(A) $\frac{3}{8}$ -6B	4							
VPOD25-40R(A) $\frac{3}{8}$ -4B	2.5	30	72.6(75.6)	11(14)	60.5(63.5)	41	20	1.5 ~ 4.9
VPOD25-40R(A) $\frac{3}{8}$ -6B	4							
VPOD25-50R(A) $\frac{3}{8}$ -4B	2.5							
VPOD25-50R(A) $\frac{3}{8}$ -6B	4							
VPOD30-20R(A) $\frac{3}{8}$ -4B	2.5							
VPOD30-20R(A) $\frac{3}{8}$ -6B	4							
VPOD30-30R(A) $\frac{3}{8}$ -4B	2.5	40	75.6(79.1)	14(17.5)	63.5(67)	41	20	1.5 ~ 4.9
VPOD30-30R(A) $\frac{3}{8}$ -6B	4							
VPOD30-40R(A) $\frac{3}{8}$ -4B	2.5							
VPOD30-40R(A) $\frac{3}{8}$ -6B	4							
VPOD30-50R(A) $\frac{3}{8}$ -4B	2.5							
VPOD30-50R(A) $\frac{3}{8}$ -6B	4							
VPOD40-20R(A) $\frac{3}{8}$ -4B	2.5	40	85.6(88.6)	11(14)	73.5(76.5)	54	30	1.1 ~ 4.8
VPOD40-20R(A) $\frac{3}{8}$ -6B	4							
VPOD40-30R(A) $\frac{3}{8}$ -4B	2.5							
VPOD40-30R(A) $\frac{3}{8}$ -6B	4							
VPOD40-40R(A) $\frac{3}{8}$ -4B	2.5							
VPOD40-40R(A) $\frac{3}{8}$ -6B	4							
VPOD40-50R(A) $\frac{3}{8}$ -4B	2.5	40	88.6(92.1)	14(17.5)	76.5(80)	54	30	1.1 ~ 4.8
VPOD40-50R(A) $\frac{3}{8}$ -6B	4							
VPOD40-50R(A) $\frac{3}{8}$ -4B	2.5							
VPOD40-50R(A) $\frac{3}{8}$ -6B	4							
VPOD40-50R(A) $\frac{3}{8}$ -4B	2.5							
VPOD40-50R(A) $\frac{3}{8}$ -6B	4							

Unit : mm

Model code	Tube I.D. øD	Pad O.D. ød	B	L1	L2	E2	Stroke S	Spring force (N)
VPOD50-20R(A)S-4B	2.5	50	76.6(79.6)	15(18)	64.5(67.5)	41	20	1.5~4.9
VPOD50-20R(A)S-6B	4							
VPOD50-30R(A)S-4B	2.5		89.6(92.6)		77.5(80.5)	54	30	1.1~4.8
VPOD50-30R(A)S-6B	4							
VPOD50-40R(A)S-4B	2.5		102.6(105.6)		90.5(93.5)	67	40	1.0~4.5
VPOD50-40R(A)S-6B	4							
VPOD50-50R(A)S-4B	2.5		115.6(118.6)		103.5(106.5)	80	50	0.9~4.5
VPOD50-50R(A)S-6B	4							

※ .Value in () is the dimension of a deep type pad.

※ [S]: Replaced with Pad rubber material code. Refer to page 820 for details.

※ .Tightening torque of a pad holder fixing bulkhead nut is 4.5~6N·m.

※ .See Pisco website for weight information.

VPOD Spring type / Side port / Female thread / No cover holder



VPOD20[R(A)S]-M6
VPOD25[R(A)S]-M6
VPOD30[R(A)S]-M6
VPOD40[R(A)S]-M6
VPOD50[R(A)S]-M6

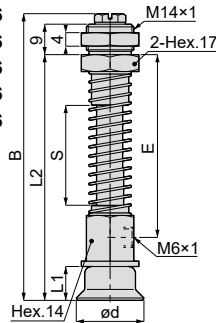

Connection
config. code
-M6

RoHS Compliant CAD (2D*3D)

Stroke (mm)
20,30,40,50

Unit : mm

Model code	Pad O.D. ød	B	L1	L2	E	Stroke S	Spring force (N)	Connection config. code
VPOD20-20R(A)S-M6	20	71.6(72.6)	10(11)	59.5(60.5)	41	20	1.5~4.9	-M6
VPOD20-30R(A)S-M6		84.6(85.6)		72.5(73.5)	54	30	1.1~4.8	
VPOD20-40R(A)S-M6		97.6(98.6)		85.5(86.5)	67	40	1.0~4.5	
VPOD20-50R(A)S-M6		110.6(111.6)		98.5(99.5)	80	50	0.9~4.5	
VPOD25-20R(A)S-M6		72.6(73.6)		60.5(61.5)	41	20	1.5~4.9	
VPOD25-30R(A)S-M6	25	85.6(86.6)	11(12)	73.5(74.5)	54	30	1.1~4.8	
VPOD25-40R(A)S-M6		98.6(99.6)		86.5(87.5)	67	40	1.0~4.5	
VPOD25-50R(A)S-M6		111.6(112.6)		99.5(100.5)	80	50	0.9~4.5	
VPOD30-20R(A)S-M6	30	72.6(75.6)	11(14)	60.5(63.5)	41	20	1.5~4.9	
VPOD30-30R(A)S-M6		85.6(88.6)		73.5(76.5)	54	30	1.1~4.8	
VPOD30-40R(A)S-M6		98.6(101.6)		86.5(89.5)	67	40	1.0~4.5	
VPOD30-50R(A)S-M6		111.6(114.6)		99.5(102.5)	80	50	0.9~4.5	
VPOD40-20R(A)S-M6	40	75.6(79.1)	14(17.5)	63.5(67)	41	20	1.5~4.9	
VPOD40-30R(A)S-M6		88.6(92.1)		76.5(80)	54	30	1.1~4.8	
VPOD40-40R(A)S-M6		101.6(105.1)		89.5(93)	67	40	1.0~4.5	
VPOD40-50R(A)S-M6		114.6(118.1)		102.5(106)	80	50	0.9~4.5	
VPOD50-20R(A)S-M6	50	76.6(79.6)	15(18)	64.5(67.5)	41	20	1.5~4.9	
VPOD50-30R(A)S-M6		89.6(92.6)		77.5(80.5)	54	30	1.1~4.8	
VPOD50-40R(A)S-M6		102.6(105.6)		90.5(93.5)	67	40	1.0~4.5	
VPOD50-50R(A)S-M6		115.6(118.6)		103.5(106.5)	80	50	0.9~4.5	

VPF Spring type / Direct mount / Metric thread / Standard holder

 RoHS Compliant  Copper alloy free available  CAD (2D&3D)

VPF1R[5][9]
VPF2R[5][9]
VPF3R[5][9]
VPF4R[5][9]

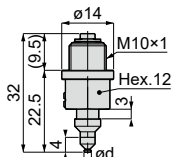

VPF6R[5][9]
VPF8R[5][9]

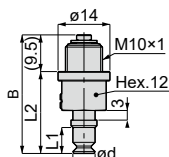

VPF10R[5][9]
VPF15R(A)[5][9]

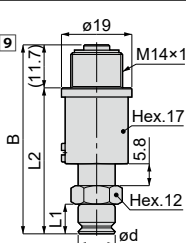

VPF20R(A)[5][9]
VPF25R(A)[5][9]
VPF30R(A)[5][9]
VPF40R(A)[5][9]
VPF50R(A)[5][9]

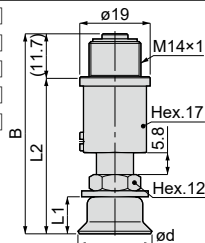

 Stroke (mm)
3, 5, 8



Unit : mm

Model code	Pad O.D. ød	B	L1	L2	Spring force (N)	Connection config. code
VPF1R[5][9]	1	—	—	—	2.3~3.9	-H3
VPF2R[5][9]	2	—	—	—	2.3~3.9	
VPF3R[5][9]	3	—	—	—	2.3~3.9	
VPF4R[5][9]	4	—	—	—	2.3~3.9	
VPF6R[5][9]	6	32	7	22.5	2.3~3.9	-T8
VPF8R[5][9]	8	30.5	5.5	21	2.3~3.9	
VPF10R[5][9]	10	51	8	39.3	7.9~15.0	-M4
VPF15R(A)[5][9]	15	52(53)	9(10)	40.3(41.3)	7.9~15.0	
VPF20R(A)[5][9]	20	54(55)	10(11)	42.3(43.3)	7.9~15.0	-M6
VPF25R(A)[5][9]	25	55(56)	11(12)	43.3(44.3)	7.9~15.0	
VPF30R(A)[5][9]	30	55(58)	11(14)	43.3(46.3)	7.9~15.0	
VPF40R(A)[5][9]	40	58(61.5)	14(17.5)	46.3(49.8)	7.9~15.0	
VPF50R(A)[5][9]	50	59(62)	15(18)	47.3(50.3)	7.9~15.0	

- ※ Value in () is the dimension of a deep type pad.
- ※ [5]: Replaced with Pad rubber material code. Refer to page 492 for details.
- ※ [9]: Replaced with "-S3" for -S3 spec. (Copper alloy free material for metal parts and FKM or HNBR for sealing parts).
- ※ Pad material N, NE, and G are not suitable for use under ozone environment.
- ※ Tightening torque for fixing a pad holder is 4.5~6N·m.
- ※ See Pisco website for weight information.





Vacuum Pad Series

Vacuum Pad Standard Series

Construction (Vacuum Pad Holder and Vacuum Pad of Small, General & Deep Type)

Pad dia. : $\phi 0.7, \phi 1, \phi 1.5, \phi 2, \phi 3, \phi 4$ mm

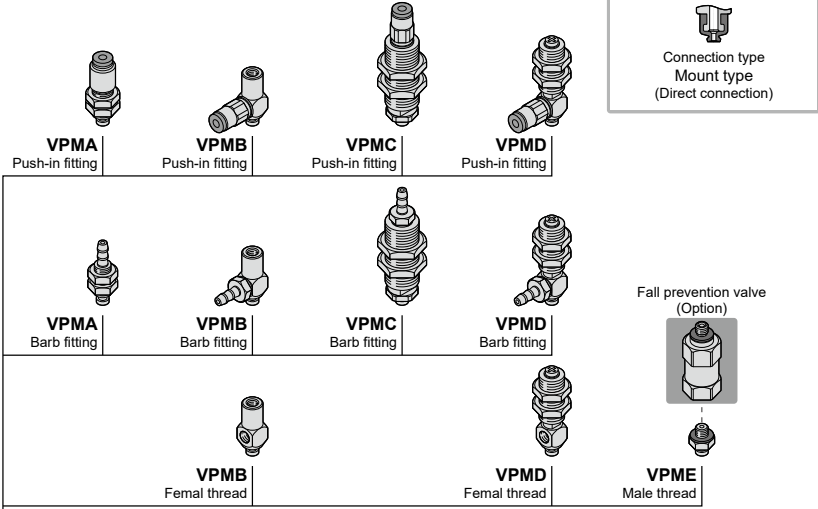

Small type pad

Pad model code	Pad dia.
VP 0.7RM[5]	$\phi 0.7$ mm
VP 1RM[5]	$\phi 1$ mm
VP 1.5RM[5]	$\phi 1.5$ mm
VP 2RM[5]	$\phi 2$ mm
VP 3RM[5]	$\phi 3$ mm
VP 4RM[5]	$\phi 4$ mm

※ The Fitting model code for option "-S3" is different from that of standard products. Contact us for details.
 ※ Model code of Vacuum Pad Holder alone is following. Contact us for price.

■ Model designation (Example)

VPM C **-T4** -2 -4B -S3
 [1] [3] [6] [9]

[1] : Holder type, [3] : Stroke (For spring type holder only), [6] : Port size • type, [9] : -S3spec.

Pad dia. : $\phi 1, \phi 2, \phi 3, \phi 4\text{mm}$

Connection config. code **-H3**

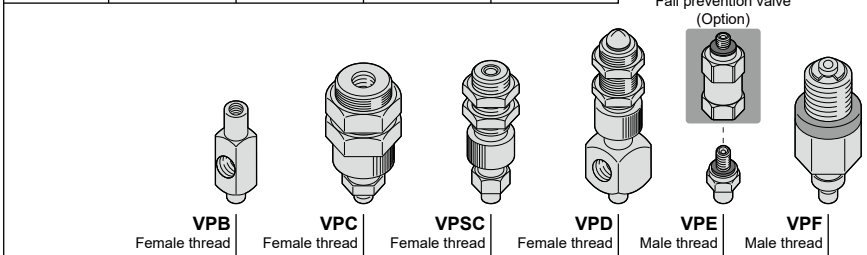
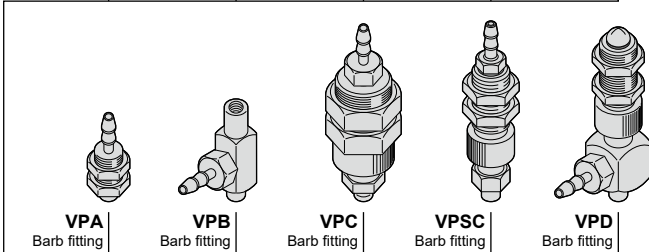
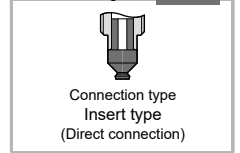
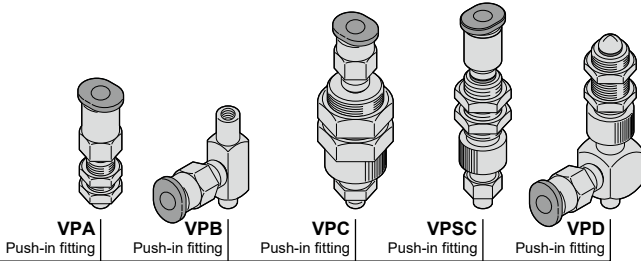

General type pad

Pad model code	Pad dia.
VP 1R ⁵	$\phi 1\text{mm}$
VP 2R ⁵	$\phi 2\text{mm}$
VP 3R ⁵	$\phi 3\text{mm}$
VP 4R ⁵	$\phi 4\text{mm}$

※ The Fitting model code for option "-S3" is different from that of standard products. Contact us for details.

※ Model code of Vacuum Pad Holder alone is following. Contact us for price.

■ Model designation (Example)

VP C -H3 -3 -4B -S3
1 3 6 9

¹ : Holder type, ³ : Stroke (For spring type holder only. VPF holder is excluded.),

⁶ : Port size • type, ⁹ : -S3spec.



Vacuum Pad Series

Vacuum Pad Standard Series

Pad dia. : $\varnothing 6, \varnothing 8\text{mm}$

Connection config. code **-T8**



Connection type
Mount type
(Direct connection)

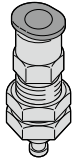

VPA
VPMA

Push-in fitting

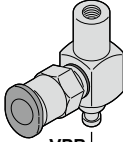

VPB
VPMB

Push-in fitting

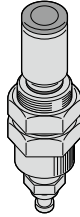

VPC
VPMC

Push-in fitting



VPSC

Push-in fitting

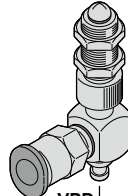

VPD
VPMD

Push-in fitting



VPA
VPMA

Barb fitting

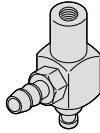

VPB
VPMB

Barb fitting

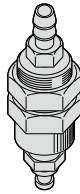

VPC
VPMC

Barb fitting



VPSC

Barb fitting

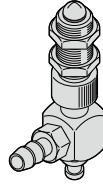

VPD
VPMD

Barb fitting

Fall prevention valve
(Option)

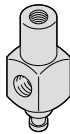
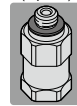

VPB
VPMB

Female thread



VPC

Female thread



VPSC

Female thread

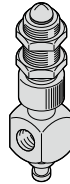

VPD
VPMD

Female thread



VPE
VPME

Male thread

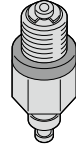

VPF

Male thread

General type pad

Pad model code	Pad dia.
VP6R	$\varnothing 6\text{mm}$
VP8R	$\varnothing 8\text{mm}$

※ The Fitting model code for option "-S3" is different from that of standard products. Contact us for details.

※ Model code of Vacuum Pad Holder alone is following. Contact us for price.

■ Model designation (Example)

VP C -T8 -3 -4B -S3

1 3 6 9

1 : Holder type, 3 : Stroke (For spring type holder only. VPF holder is excluded),

6 : Port size • type, 9 : -S3spec.

Pad dia. : $\phi 10, \phi 15\text{mm}$

Connection config. code **-M4**



Connection type
Screw type
(Connection with screw)

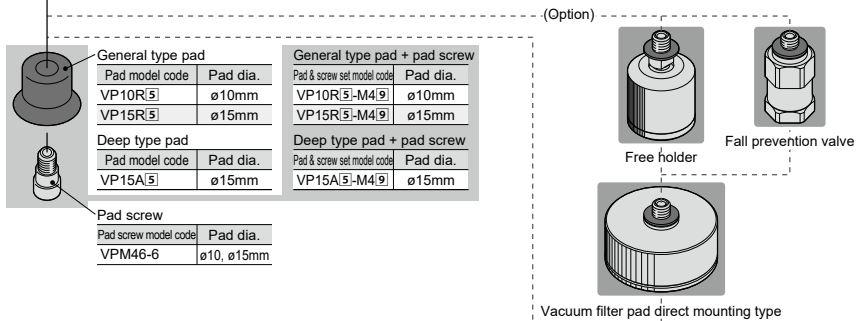
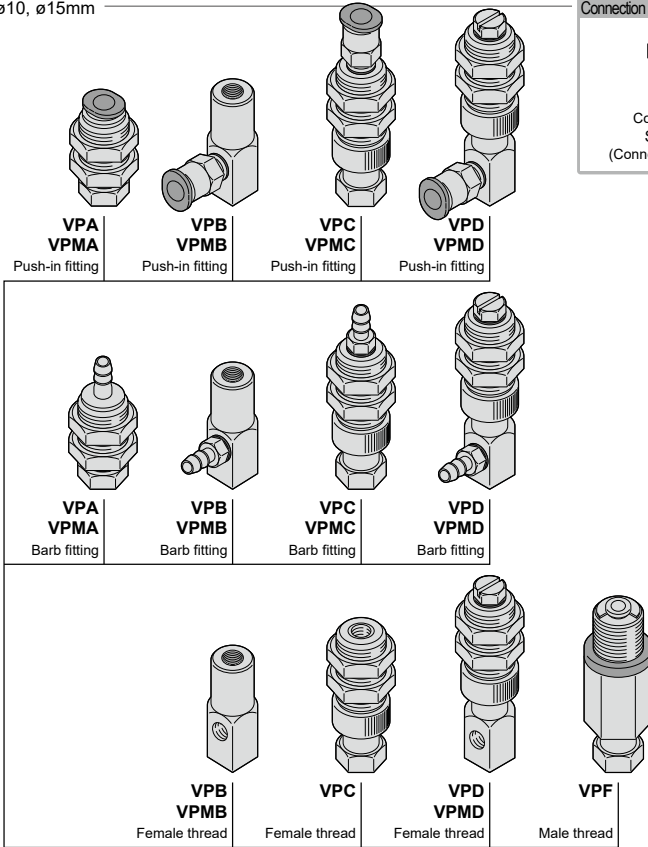

※ The Fitting model code for option "-S3" is different from that of standard products. Contact us for details.

※ Model code of Vacuum Pad Holder alone is following. Contact us for price.

■ Model designation (Example)

VP C -M4 -6 -4B -S3

1 3 6 9

1 : Holder type, 3 : Stroke (For spring type holder only. VPF holder is excluded.), 6 : Port size • type, 9 : -S3 spec.



Vacuum Pad Series

Vacuum Pad Standard Series

Pad dia. : $\varnothing 20$, $\varnothing 25$, $\varnothing 30$, $\varnothing 40$, $\varnothing 50$ mm

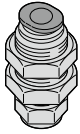

VPA
VPMA
Push-in fitting

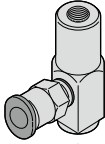

VPB
VPMB
Push-in fitting

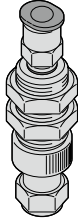

VPC
VPMC
Push-in fitting



VPOC
Push-in fitting

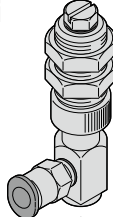

VPD
VPMD
Push-in fitting

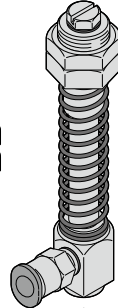

VPOD
Push-in fitting



VPA
VPMA
Barb fitting

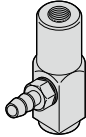

VPB
VPMB
Barb fitting

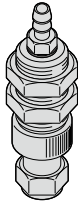

VPC
VPMC
Barb fitting

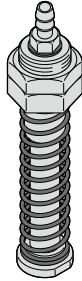

VPOC
Barb fitting

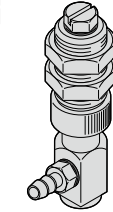

VPD
VPMD
Barb fitting

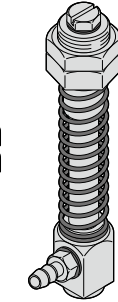

VPOD
Barb fitting

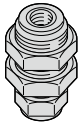

VPA
Female thread



VPB
VPMB
Female thread



VPC
Female thread

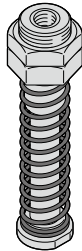

VPOC
Female thread

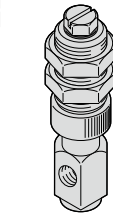

VPD
VPMD
Female thread

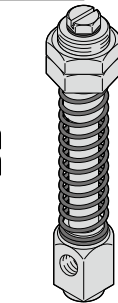

VPOD
Female thread

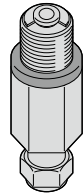

VPF
Male thread

Connection config. code **-M6**

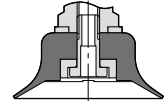

Connection type
Screw type
(Connection with screw)

(Option)

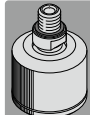

Free holder

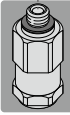

Fall prevention valve

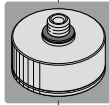

Vacuum filter pad direct mounting type

General type pad + pad screw, etc.

Pad & screw set model code	Pad dia.
VP20R[5]-M6[9]	ø20mm
VP25R[5]-M6[9]	ø25mm
VP30R[5]-M6[9]	ø30mm

Deep type pad + pad screw, etc.

Pad & screw set model code	Pad dia.
VP20A[5]-M6[9]	ø20mm
VP25A[5]-M6[9]	ø25mm
VP30A[5]-M6[9]	ø30mm

General type pad + pad screw, etc.

Pad & screw set model code	Pad dia.
VP40R[5]-M6[9]	ø40mm
VP50R[5]-M6[9]	ø50mm

Deep type pad + pad screw, etc.

Pad & screw set model code	Pad dia.
VP40A[5]-M6[9]	ø40mm
VP50A[5]-M6[9]	ø50mm

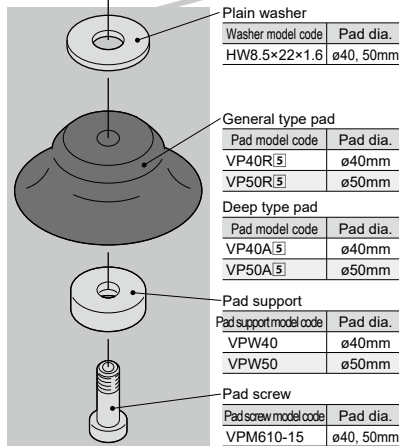
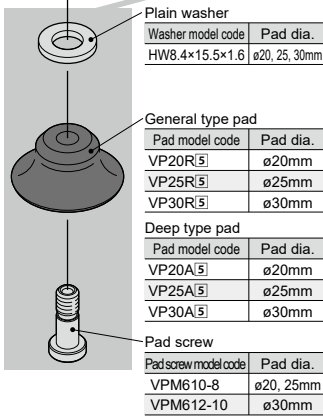

※ The Fitting model code for option "-S3" is different from that of standard products. Contact us for details.

※ Model code of Vacuum Pad Holder alone is following. Contact us for price.

■ Model designation (Example)

VP C -M6 -6 -6B -S3

[1]

[3]

[6]

[9]

[1] : Holder type, [3] : Stroke (For spring type holder only. VPF holder is excluded.), [6] : Port size + type, [9] : -S3spec.



Pad dia. : $\varnothing 60, \varnothing 80, \varnothing 100\text{mm}$

Connection config. code **-M10**

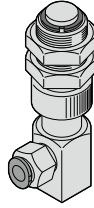
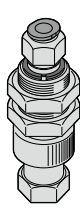
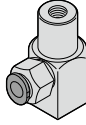
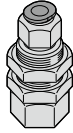

VPA

VPB

VPC

VPD

Push-in fitting

Push-in fitting

Push-in fitting

Push-in fitting

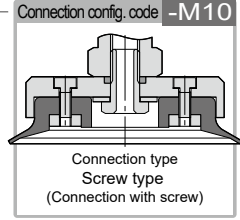

Connection type
Screw type
(Connection with screw)

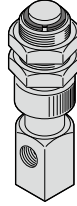
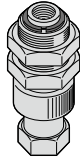
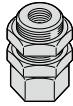

VPA

VPB

VPC

VPD

Parallel female thread

Parallel female thread

Parallel female thread

Parallel female thread

(Option)

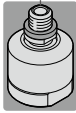

Free holder



Fall prevention valve

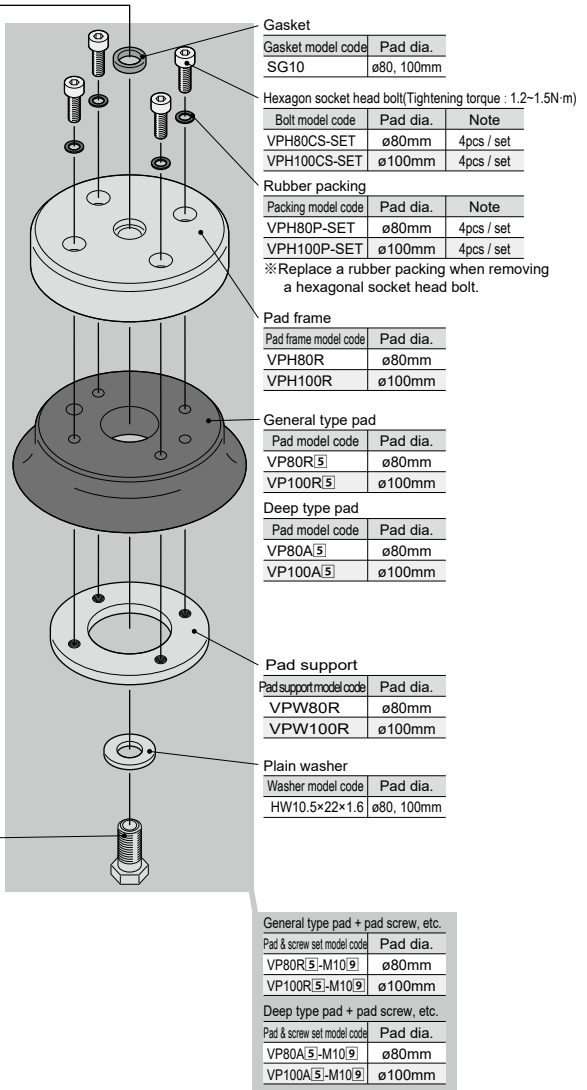
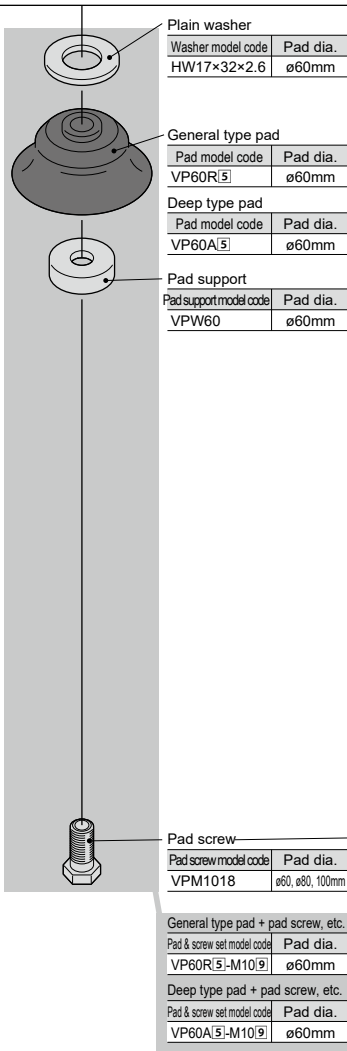

※"-S3" is available for parallel female thread holder only.

※Model code of Vacuum Pad Holder alone is following. Contact us for price.

■ Model designation (Example)

VP C **-M10** -10 -G1 -S3

①

③

⑥

⑨

① : Holder type, ③ : Stroke (For spring type holder only.), ⑥ : Port size • type, ⑨ : -S3 spec.



Pad dia. : $\varnothing 150, \varnothing 200\text{mm}$

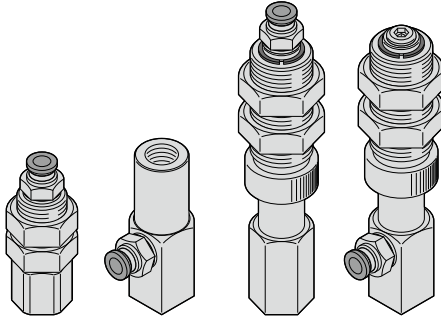

VPA	VPB	VPC	VPD
Push-in fitting	Push-in fitting	Push-in fitting	Push-in fitting

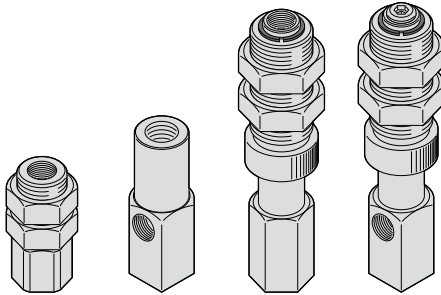
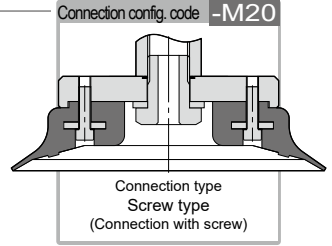

VPA	VPB	VPC	VPD
Parallel female thread	Parallel female thread	Parallel female thread	Parallel female thread

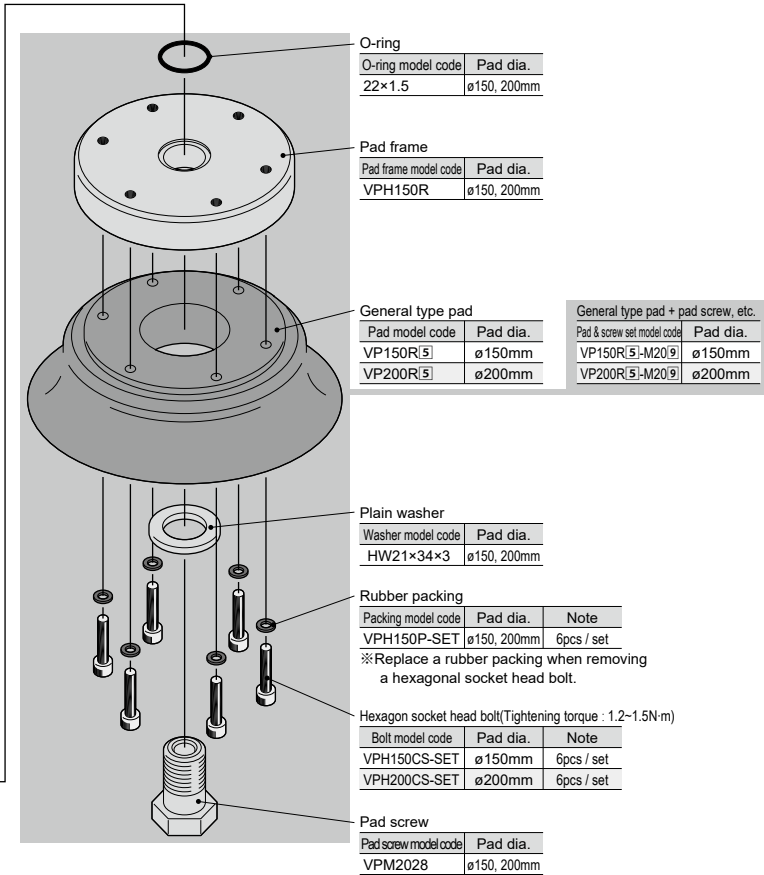

※"-S3" is available for parallel female thread holder only.

※Model code of Vacuum Pad Holder alone is following. Contact us for price.

■ Model designation (Example)

VP C -M20 -20 -G2 -S3
① ③ ⑥ ⑨

① : Holder type, ③ : Stroke (For spring type holder only.), ⑥ : Port size • type, ⑨ : -S3spec.



Vacuum Pad Series

Vacuum Pad Standard Series

⚠ Common Safety Instructions for Vacuum Pads

Before selecting or using PISCO products, read the following instructions. Read the detailed instructions for individual series.

⚠ Warning

1. Take safety measures in advance where a dropping work-piece can cause danger.
2. Make sure to install a vacuum pad holder securely. Looseness may cause trouble.
3. Pay special attention to the work conveyance by screwed vacuum pads, accompanied by rotary movement. There is a possibility of troubles due to the looseness of screws from the rotary movement.
4. There is a possibility of troubles due to the leakage of vacuum system, clogging, vacuum pad abrasion, crack, deterioration, the galling of slider part in the holder and the looseness in joints. Carry out maintenance inspection periodically.
5. When a work-piece is conveyed by a vacuum pad, consider the acceleration, impacts and wind pressure. Otherwise, the work-piece may drop during conveyance.

⚠ Caution

1. Thoroughly read and understand the theoretical suction force in this catalog before selecting diameter, Qty and suction place of vacuum pads. Select vacuum pads with enough margin in suction force.
2. The product incorporating NBR as seal rubber material has a risk of malfunction caused by ozone crack. Ozone exists in high concentrations in static elimination air, clean-room, and near the high-voltage motors, etc. As a countermeasure, material change from NBR to HNBR or FKM is necessary. Consult with Pisco for more information.
3. Select the material of vacuum pad in accordance with use environment and ease of use, referring to "Selecting Method".
4. Select the suitable pad shape (type) in accordance with a work-piece and its shape, referring to "Characteristics of Pad Material".
5. Select spring-holder type when work-pieces have different heights or are weak against an external force. Select the suitable holder type, referring to spring force and spring length in the catalog.
6. Since spring-holder type has a sliding action, minimize the transverse load. Otherwise, the life time of the holder can be reduced or malfunction of the holder can occur.
7. In replacing vacuum pads, check the structure of holders and pads in the catalog and tighten the hexagonal-column of the holder with a proper tool, referring to the following tightening torque.

● Table. tightening torque

Vacuum pad holder	Standard	Mini
Pad screw size (mm)	Tightening torque (N·m)	
M4×0.7	0.5 ~ 1.0	0.9 ~ 1.1
M6×1	2 ~ 2.7	
M10×1.5	5 ~ 7	—
M20×2	9 ~ 10	—

8. In replacing the adapters of Soft / Soft Bellows Series, check the structure of holders, pad and adapters and tighten the hexagonal-column of the holder with a proper tool, referring to the following tightening torque.

● Table. tightening torque

Pad screw size (mm)	Tightening torque (N·m)
M4×0.7	0.7 ~ 0.8
M6×1	1.5 ~ 2.0

9. In installing vacuum pad holders of general and small type with bulkhead, check the structure and tighten the hexagonal-column of the holder with a proper tool, referring to the following tightening torque.

Vacuum pad holder	Standard			Mini		
Vacuum pad holder type	VPA	VPC, VPD, VPF, VPHC, VPHD, VPHDW	VPE	VPMA	VPMC, VPMD	VPME
Bulkhead nut size (mm)	Tightening torque (N·m)					
M3×0.5	—	—	0.7	—	—	0.7
M4×0.5	—	—	—	1 ~ 1.2	—	—
M4×0.7	1 ~ 1.2	—	—	—	—	—
M5×0.5	1.5 ~ 2	—	—	1.5 ~ 2	—	—
M5×0.8	—	—	1 ~ 1.5	—	—	1 ~ 1.5
M6×0.75	2 ~ 3	—	—	2 ~ 3		—
M8×0.75	2.5 ~ 3.5	1.8 ~ 2.4	—	2.5 ~ 3.5		—
M8×1	—	1.8 ~ 2.4	—	—	—	—
M10×1	5 ~ 7	4.5 ~ 6	—	5 ~ 7	4 ~ 6	—
M12×1	12 ~ 14	8 ~ 10	—	—	—	—
M14×1	18 ~ 21	4.5 ~ 6	—	—	—	—
M16×1	18 ~ 21(※)	2 ~ 3	—	—	—	—
M20×1	19 ~ 21	—	—	—	—	—
M22×1	19 ~ 21(※)	16 ~ 20	—	—	—	—
M24×2	40 ~ 50	—	—	—	—	—
M30×2	—	42 ~ 54	—	—	—	—

※Values for Vacuum pad holder for Packaging bag series.

10. In replacing vacuum pad rubbers of Standard Series ø80, ø100mm, ø150mm, ø200mm and Bellows Series ø80mm, ø100mm, check the structure of holders and pads and tighten the hexagonal-column of the holder with a proper tool, referring to the following tightening torque.

● Table. tightening torque

Pad screw size (mm)	Tightening torque (N·m)
M4×0.7	0.5 ~ 0.7
M5×0.8	

11. Check the structure of vacuum pad in the catalog before replacing a filter element.

12. Refer to "Common Safety Instructions for Fittings" for handling fitting joint parts.

13. In installing spring-holder type, do not hold the shaft (A) with a spanner.

In replacing vacuum pad, hold the hexagonal-column of the shaft with a spanner. If the keyway (B) is deformed, there is a possibility of malfunction.

14. Excessive tightening of a fixing nut may deform the bulkhead part and result in malfunction of the keyway.

15. As the nature of rubber, powdery component like additives may come out on the surface of a vacuum pad as time elapses.

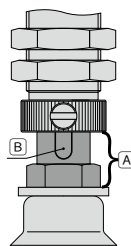

Vacuum Pad Selection Guide

Selection Guide 1 ▶ Select the diameter of vacuum pad from the formula ① and chart of the theoretical suction force ②

The theoretical suction force is determined from pad area and vacuum level. Calculated value is for reference only, so carry out the evaluation under an actual operating condition. The theoretical suction force is calculated under a static condition. Obtain an enough margin, considering the weight of a work-piece and acceleration of lifting, pause and rotary movement. Enough room is needed in deciding a number of pads and arrangement position.

① Calculation by formula

$$W = \frac{C \times P}{101} \times 10.13 \times f$$

- W : Suction force(N)
- C : Pad area(cm²)
- P : Vacuum level -kPa
- f : Safety factor Horizontal lifting (refer to the right fig.) ▶ 1/4
Vertical lifting (refer to the right fig.) ▶ 1/8

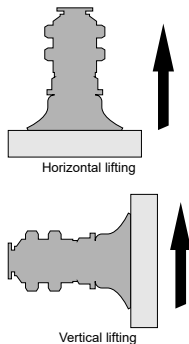

- *1.Refer to the following chart for Sponge Series.(Internal diameter is used for calculation)
- *2.Refer to the following chart for Flat Series.(Pad grooves are used for calculation)
- *3.As for Bellows, Multi-Bellows, Soft, Soft Bellows and Ultrathin Series, their theoretical suction force may exceed the strength of pad itself, depending on the vacuum level. Carry out the evaluation under an actual operating condition.

② Chart of the theoretical suction force <Add safety factor to values from the chart>

Standard / Bellows / Multi-bellows / Soft / Soft bellows / Skidproof / Ultrathin / Mark-free (*)

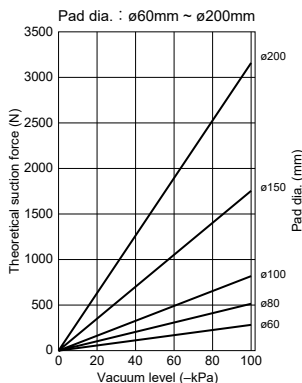
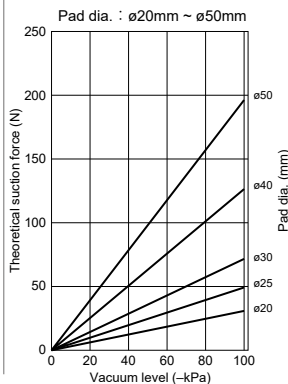
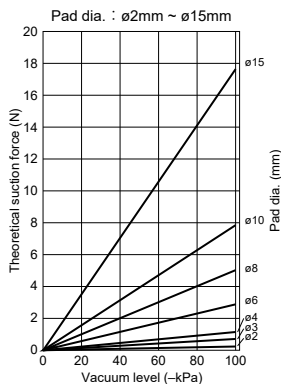
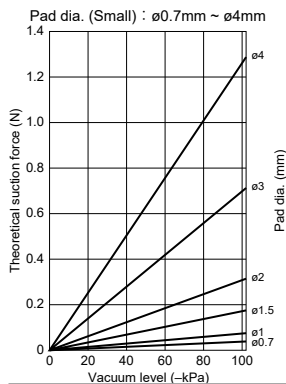

*Some sizes are not available for some pad series. Refer to the following size list.

● : indicates that pad size is available

Pad type	Standard	Bellows	Multi-bellows	Soft	Soft bellows	Skidproof	Ultra thin	Mark-free
ø0.7~ø3	●	—	—	—	—	—	—	—
ø4	●	—	—	●	—	—	—	—
ø6	●	●	—	●	●	—	—	—
ø8	●	●	—	●	●	—	●	—
ø10	●	●	●	●	●	●	—	●
ø15	●	●	●	●	●	●	●	—
ø20	●	●	●	●	●	●	●	●
ø25	●	●	—	—	—	—	—	—
ø30	●	●	●	●	—	●	—	●
ø40	●	●	●	●	—	●	—	—
ø50	●	●	●	—	—	●	—	—
ø60	●	●	—	—	—	—	—	—
ø80	●	●	—	—	—	—	—	—
ø100	●	●	—	—	—	—	—	—
ø150	●	—	—	—	—	—	—	—
ø200	●	—	—	—	—	—	—	—

Sponge pad

Pad dia. : ϕ 10mm ~ ϕ 100mm

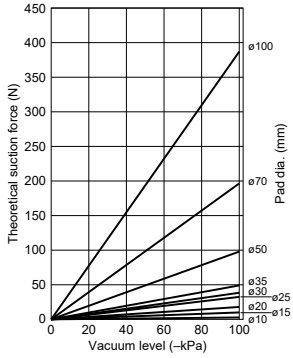

Flat pad

Pad dia. : ϕ 10mm ~ ϕ 30mm

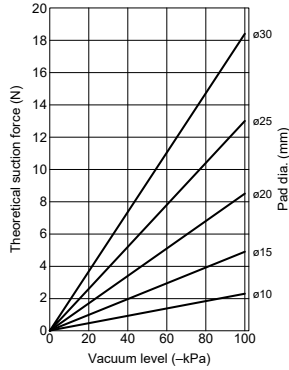

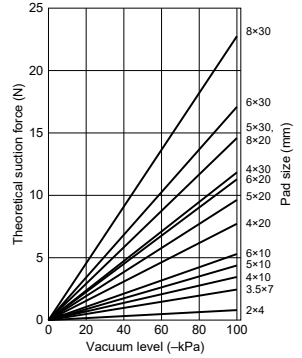

Oval pad

Pad size : 2×4mm ~ 8×30mm

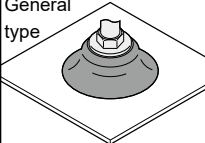
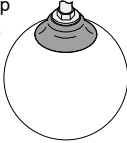

Selection Guide 2 ▶ Select a vacuum pad type according to a work-piece.

Please select suitable pads for your application from the following.

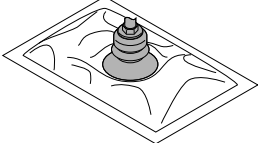
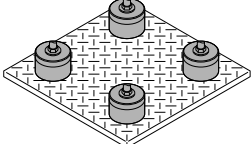
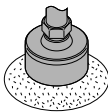
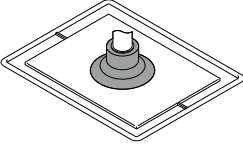
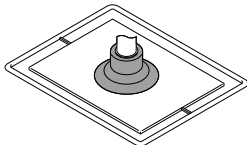
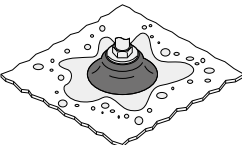
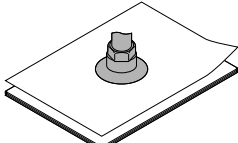
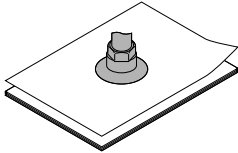
Standard Series			Bellows / Multi-bellows Series
General type 	Deep type 	Small type 	
Thick & flat work-piece	Round fruit or ball (*1)	Small work-piece or semiconductor manufacturing device	Food package
Sponge Series		Oval Series	
			
Exterior wall panel, pebble, seashell		Long work-piece (e.g. circuit board and semiconductor product)	
Soft / Soft bellows Series	Skidproof Series	Mark-free Series	
			
Taking out molded parts / Fragile work-piece	Greasy work-piece such as pressed parts	LCD glass / in Painting process / semiconductor manufacturing device	
Ultrathin Series		Flat Series	
			
Thin work-piece such as paper or plastic bag		Thin work-piece such as sheet or plastic bag	

*1.The table below is a reference for the vacuum pad deep type and the size of round work-piece.

Spherical dia. : S (mm)	ø20	ø30	ø40	ø50	ø80	ø100	ø120	ø160	ø200
Pad size : d (mm)	ø15	ø20	ø25	ø30	ø40	ø50	ø60	ø80	ø100

*2.Refer to the previous page for pad dia. selection except deep type. Refer to the next page for the characteristics of pad materials.

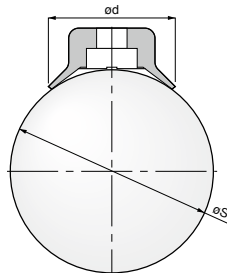

Selection Guide 2 ▶ Select a vacuum pad material from an application..

Please select the suitable material from the table.

Item	Pad material	Nitrile rubber	NBR Suited for the food sanitation act. (Japan)	HNBR	Silicone rubber	Conductive Silicone rubber	Urethane rubber	Fluoro rubber	Fluorosilicone rubber	EPDM	Conductive Butadiene rubber (Low resistance type)	Conductive NBR (low resistance)	Chloroprene rubber (For Sponge type)	Silicone rubber (For Sponge Type)		
	Material code	N, NH (*1)	G	HN	S	SE	U	F	FS	EP	E	NE	-	S		
Application		Cardboard Plywood Metal plate Food-related Other general work	Cardboard Plywood Metal plate Food-related Other general work In use under a low ozone concentration environment.	Semiconductors Taking out molded parts Thin work-piece Food-related	Cardboard Plywood Metal plate	Chemical environment High temp. work-pieces	Taking out molded parts	Application that requires light-resistant or ozoneproof In use under the moisture containing atmosphere	General pars of semiconductors	Semi-conductors	Uneven work-piece	Uneven work-piece Food-related				
Pad color		Black	Gray	Black	Translucent	Black	Blue	Gray	Salmon	Black	Black	Black	Black	Salmon		
Physical Properties	Surface hardness (Shore A)	Standard	50°~80°	60°~70°	50°~70°	50°	60°	55°~70°	60°~70°	-	50°~70°	70°	60°~70°	-	-	
		Bellows	50°	-	50°	50°	60°	55°	60°	-	50°	-	60°	-	-	
		Multi-bellows	50°	50°	50°	50°	50°	-	55°	50°	-	50°	-	60°	-	-
		Oval	40°~50°	-	50°	40°~50°	50°~60°	55° (*2)	50° (*2)	-	50°	70°	70°	-	-	
		Soft	40°	-	-	40°	60°	-	-	40°	-	-	50°	-	-	
		Soft bellows	40°	-	50°	40°	-	55°	-	-	50°	-	60°	-	-	
		Skidproof	50°	-	-	50°	-	55°	60°	-	-	-	60°	-	-	
		Ulthrathin	40°	-	-	40°	-	55°	50°	40°	-	-	60°	-	-	
	Flat	60°	-	-	40°	40°	50°	50°	-	-	-	60°	-	-		
	Highest operating temp.		110°C	140°C	180°C	60°C	230°C	180°C	150°C	100°C	110°C	80°C	180°C			
	Lowest operating temp.		-30°C	-30°C	-40°C	-20°C	-10°C	-50°C	-40°C	-50°C	-30°C	-45°C	-40°C			
	Weatherability		△	○	◎	◎	◎	◎	◎	◎	◎	△	○	◎		
	Ozone-proof		×	○	◎	◎	◎	◎	◎	◎	×	×	○	◎		
	Acid-resistance		△	△	○	×	◎	○	◎	△	△	△	○			
Alkaline-resistance		○	○	◎	×	◎	◎	◎	○	○	◎	◎				
Oil resistance	(Gasoline oil)	◎	◎	△	◎	◎	△	×	×	◎	×	×	△			
	(Benzene/toluene)	△	×	△	△	◎	△	×	×	△	△	△				
Volume resistance		-	-	-	Max. 10 ¹⁰ Ω·cm	-	-	-	-	Max. 2000Ω·cm	Max. 2000Ω·cm	-	-			

Legend ⇄
 ◎ : Best
 ○ : Suitable
 △ : Good
 × : NG

*1. Material code "NH" is only available for Skidproof Series.

*2. It does not apply to pad size: 4×30mm.

Note 1). The above "Physical Properties" shows the data of general synthetic rubbers.

Note 2). The highest / lowest operating temp. is for momentary usage. Carry out durability evaluation in case of continuous usage under the highest / lowest operating temp.

Please select the suitable vacuum pad resin material from the table.

Item	Pad material		PEEK	POM	Conductive PEEK
	Material code	Mark free series Resin attachment for Bellows series	K -QK	M -QM	KE -QKE
Application			Manufacturing machine for liquid crystal / semiconductor	General production line Food-related machine Packaging machine	Manufacturing machine for liquid crystal / semiconductor Electronic components
Pad color			Natural (ivory)	White	Black
Physical Properties	Highest operating temp.		250°C	95°C	250°C
	Lowest operating temp.		-50°C	-60°C	-50°C
	Weatherability		◎	×	◎
	Acid-resistance		◎	×	◎
	Alkaline-resistance		◎	△	◎
	Self-lubricity		○	◎	○
	Abrasion-resistance		◎	◎	◎
Volume resistance		-		-	10 ⁸ ~10 ⁹ Ω·cm

Legend ◎ : Best
○ : Suitable
△ : Good
× : NG

Note 1).The above "Physical Properties" shows the data of pad resin material only. The holder of Mark-free Series is not included.

Note 2).The above "Physical Properties" shows the data of resin attachment only. The pad rubber is not included.

Note 3).The above "Physical Properties" shows a general properties of resin materials and not a guaranteed value. Carry out the necessary evaluation under an actual operating condition.

Note 4).The highest / lowest operating temp. is for momentary usage. Carry out durability evaluation in case of continuous usage under the highest / lowest operating temp.

Note 5).Volume resistance is a representative value from the material manufacture, and not a guaranteed value.

To prevent dust from getting into the pad holder.

Install a vacuum filter pad direct mounting type between a vacuum pad and a holder.

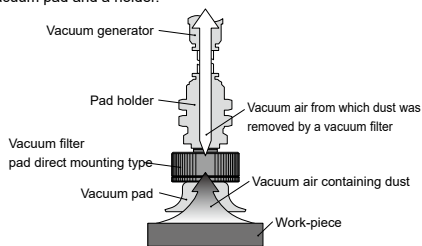

To prevent dust from getting into the pad holder.

Installing a fall prevention valve between a vacuum pad and a holder prevents the troubles like system break down, minimizing the vacuum drop of the whole system automatically by reducing suction flow of the part where the work-piece falls from the vacuum pad (within the range not causing any problem), or no work-piece is to be sucked.

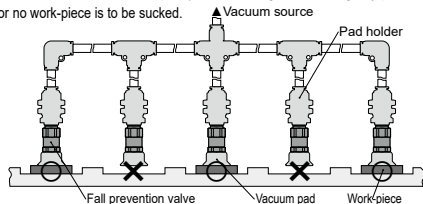

Reference Guide for Vacuum Pad

Impact on pad

Avoid an impact or a large force on a vacuum pad, when it is pressed against a work-piece. It may cause deformation, crack or abrasion at an early stage of use. Adjust the pad position so that the lip of pad touches lightly on a work-piece. Especially a small type of vacuum pad should be positioned precisely.

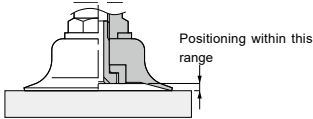

Porous or perforated work-piece

Since the suction of a porous work-piece causes a drop of suction force, select the proper specifications of vacuum system and secure a larger effective crosssection area of the piping. Selecting a small type of vacuum pad is one of solutions to reduce the air leakage.

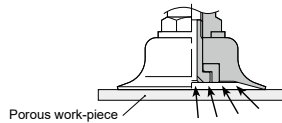

Large and wide flat plate work-piece

When lifting large size of glass board or circuit board, work-piece may bend by the lifting acceleration or the self-weight. Select a proper size of pad and positioning, considering an enough margin of suction force.

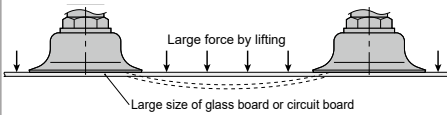

Lifting work-piece, sucking the both side of it

Since all vacuum pad holders are designed for horizontal lifting, consider the strength of holders and pads.

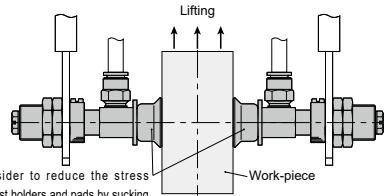

Soft work-piece

When soft work-pieces such as plastic bags, papers or thin boards are sucked, work-pieces can be deformed or shrunk by vacuum suction (Figure-1). Select smaller vacuum pads and reduce the vacuum pressure. Smaller vacuum pads are suitable for plastic bags and papers. When plastic / paper bags are opened by using vacuum pads, shift the center of two vacuum pads slightly in order to open them easily as Figure-2 shows.

•Figure-1

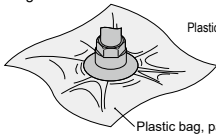

•Figure-2

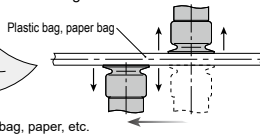

Work-piece with different heights

Select Long Stroke holders for work-pieces having different heights, or piled-up work-pieces. Its stroke can absorb the difference in height.

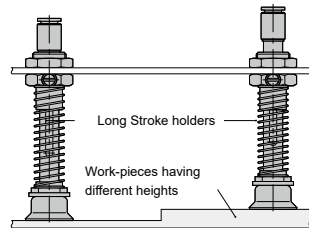

Inclined work-piece

Select Free Holder for an inclined work-piece.

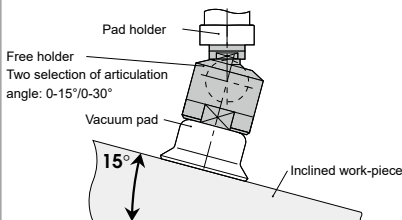

Conveyance with rotary movement

When vacuum pad is fixed with a screw and has a rotary movement, the pad may drop due to the loosened screw. Pay special attention when the vacuum location of work-piece is off the center of work-piece gravity.

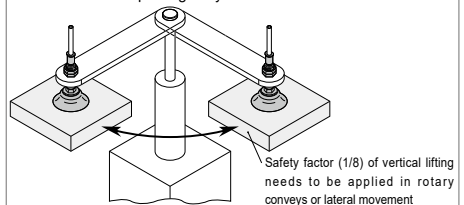



■ Pad dia. list by pad type and material

Pad material		N : Nitrile rubber							
Pad type	Standard			Bellows	Multi-Bellows	Soft	Soft bellows	Ultrathin	Flat
	General type	Deep type	Small type						
Pad dia. (mm)	ø0.7			●					
	ø1	●		●					
	ø1.5			●					
	ø2	●		●					
	ø3	●		●					
	ø4	●		●			●		
	ø6	●			●		●	●	
	ø8	●			●		●	●	●
	ø10	●			●	●	●	●	●
	ø15	●	●		●		●	●	●
	ø20	●	●		●	●	●	●	●
	ø25	●	●		●				●
	ø30	●	●		●	●	●		●
	ø40	●	●		●	●	●		
	ø50	●	●		●	●			
	ø60	●	●		●				
	ø80	●	●		●				
	ø100	●	●		●				
ø150	●								
ø200	●								

● : Available

Pad material		S : Silicone rubber									
Pad type	Standard			Bellows	Multi-Bellows	Soft	Soft bellows	Flat	Skidproof	Ultrathin	Sponge
	General type	Deep type	Small type								
Pad dia. (mm)	ø0.7			●							
	ø1	●		●							
	ø1.5			●							
	ø2	●		●							
	ø3	●		●							
	ø4	●		●			●				
	ø6	●			●		●	●			
	ø8	●			●		●	●		●	
	ø10	●			●	●	●	●	●	●	●
	ø15	●	●		●		●	●	●	●	●
	ø20	●	●		●	●	●	●	●	●	●
	ø25	●	●		●				●		●
	ø30	●	●		●	●	●		●	●	●
	ø35										●
	ø40	●	●		●	●	●			●	●
	ø50	●	●		●	●				●	●
	ø60	●	●		●					●	●
	ø70										●
ø80	●	●		●							
ø100	●	●		●						●	
ø150	●										
ø200	●										

● : Available

Pad material		U : Urethane rubber								
Pad type	Standard			Bellows	Multi-Bellows	Soft bellows	Skidproof	Ultrathin	Flat	
	General type	Deep type	Small type							
Pad dia. (mm)	ø0.7			●						
	ø1	●		●						
	ø1.5			●						
	ø2	●		●						
	ø3	●		●						
	ø4	●		●						
	ø6	●			●		●			
	ø8	●			●		●		●	
	ø10	●			●	●	●	●	●	●
	ø15	●	●		●		●		●	●
	ø20	●	●		●	●	●	●	●	●
	ø25	●	●		●					●
	ø30	●	●		●	●				●
	ø40	●	●		●	●		●		
	ø50	●	●		●	●		●		
	ø60	●	●		●					
	ø80	●	●		●					
	ø100	●	●		●					
ø150	●									
ø200	●									

● : Available

Pad material		F : Fluoro rubber							G : NBR Suited for the food sanitation act. (Japan)				
Pad type	Standard			Bellows	Multi-Bellows	Skidproof	Ultrathin	Flat	Standard			Multi-Bellows	
	General type	Deep type	Small type						General type	Deep type	Small type		
Pad dia. (mm)	ø0.7			●								●	
	ø1	●		●					●			●	
	ø1.5			●								●	
	ø2	●		●					●			●	
	ø3	●		●					●			●	
	ø4	●		●					●			●	
	ø6	●			●				●				
	ø8	●			●			●	●				
	ø10	●			●	●	●	●	●				●
	ø15	●	●		●		●	●	●	●	●		
	ø20	●	●		●	●	●	●	●	●	●		●
	ø25	●	●		●				●	●	●		
	ø30	●	●		●	●	●		●	●	●		●
	ø40	●	●		●	●	●		●	●	●		●
	ø50	●	●		●	●	●			●	●		●
	ø60	●	●		●								
	ø80	●	●		●								
	ø100	●	●		●								
ø150	●												
ø200	●												

● : Available



Vacuum Pad

Vacuum Pad

Pad material	SE : Conductive Silicone rubber					E : Conductive Butadiene rubber (Low resistance type)		S : Chloroprene rubber	NH : Oilproof NBR
	Standard		Bellows	Soft	Flat	Standard		Sponge	Skidproof
	General type	Small type				General type	Small type		
Pad dia. (mm)	ø0.7		●				●		
	ø1	●	●				●	●	
	ø1.5		●				●	●	
	ø2	●	●				●	●	
	ø3	●	●				●	●	
	ø4	●	●		●		●	●	
	ø6	●		●	●		●		
	ø8	●		●	●		●		
	ø10	●		●	●	●	●	●	●
	ø15	●		●	●	●	●	●	●
	ø20	●		●	●	●	●	●	●
	ø25	●		●	●	●	●	●	●
	ø30	●		●	●	●	●	●	●
	ø35							●	
	ø40	●		●	●		●		●
	ø50	●		●			●	●	●
	ø60	●		●					
	ø70							●	
	ø80	●		●					
	ø100	●		●				●	
ø150	●								
ø200	●								

● : Available

487

Pad material	NE : Conductive NBR (low resistance)										
	Pad type	Standard			Bellows type	Multi-Bellows	Soft	Soft bellows	Skidproof	Ultrathin	Flat
General type		Deep type	Small type								
Pad dia. (mm)	ø0.7			●							
	ø1	●		●							
	ø1.5			●							
	ø2	●		●							
	ø3	●		●							
	ø4	●		●			●				
	ø6	●			●		●	●			
	ø8	●			●		●	●		●	
	ø10	●			●	●	●	●	●	●	●
	ø15	●	●		●	●	●	●	●	●	●
	ø20	●	●		●	●	●	●	●	●	●
	ø25	●	●		●						●
	ø30	●	●		●	●	●		●		●
	ø40	●	●		●	●	●		●		
	ø50	●	●		●	●			●		
	ø60	●	●		●						
	ø80	●			●						
	ø100	●	●		●						
	ø150	●									
	ø200	●									

● : Available

Pad material		HN : HNBR						EP : EPDM					FS : Fluorosilicone rubber	
		Standard			Bellows	Multi-Bellows	Soft bellows	Standard		Bellows type	Multi-Bellows	Soft bellows	Soft	Ultrathin
Pad type		General type	Deep type	Small type				General type	Deep type					
Pad dia. (mm)	ø0.7			●				●						
	ø1	●		●				●		●				
	ø1.5			●						●				
	ø2	●		●				●		●				
	ø3	●		●				●		●				
	ø4	●		●				●		●				
	ø6	●			●			●		●		●	●	
	ø8	●			●			●		●		●	●	●
	ø10	●			●	●		●		●	●	●	●	●
	ø15	●	●		●	●		●	●	●	●	●	●	●
	ø20	●	●		●	●	●	●	●	●	●	●	●	●
	ø25	●	●		●			●	●	●				
	ø30	●	●		●	●		●	●	●			●	
	ø40	●	●		●	●		●	●	●			●	
	ø50	●	●		●	●		●	●	●				
	ø60	●	●		●			●	●	●				
ø80	●	●		●			●	●	●					
ø100	●	●		●			●	●	●					
ø150	●						●							
ø200	●						●							

● : Available

Pad material	N Nitrile rubber	S Silicone rubber	U Urethane rubber	F Fluoro rubber	SE Conductive Silicone rubber	E Conductive Butadiene rubber (Low resistance type)	NE Conductive NBR (Low resistance type)	HN HNBR	EP EPDM
Pad type	Oval								
Pad dia. (mm)	2×4	●	●	●	●			●	●
	3.5×7	●	●	●	●			●	●
	4×10	●	●	●	●		●	●	●
	4×20	●	●	●	●		●	●	●
	4×30	●	●			●	●	●	●
	5×10	●	●	●	●	●	●	●	●
	5×20	●	●	●	●	●	●	●	●
	5×30	●	●	●	●	●	●	●	●
	6×10	●	●	●	●	●	●	●	●
	6×20	●	●	●	●	●	●	●	●
	6×30	●	●	●	●	●	●	●	●
8×20	●	●	●	●	●	●	●	●	
8×30	●	●	●	●	●	●	●	●	

● : Available

Pad material	K : PEEK	M : POM	KE : Conductive PEEK	Q2K : PEEK	Q2M : POM	Q2KE : Conductive PEEK
Pad type	Mark free			Resin attachment for Bellows series		
Pad dia. (mm)	ø10	●	●	●		●
	ø15				●	●
	ø20	●	●	●	●	●
	ø25				●	●
	ø30	●	●	●	●	●

● : Available

■ Construction (VPA holder : Fixed type / Top port)

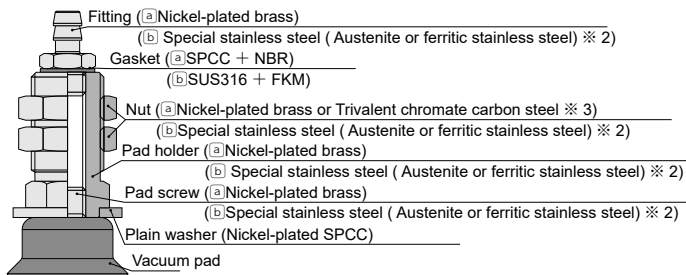

■ Construction (VPC holder : Spring type / Top port)

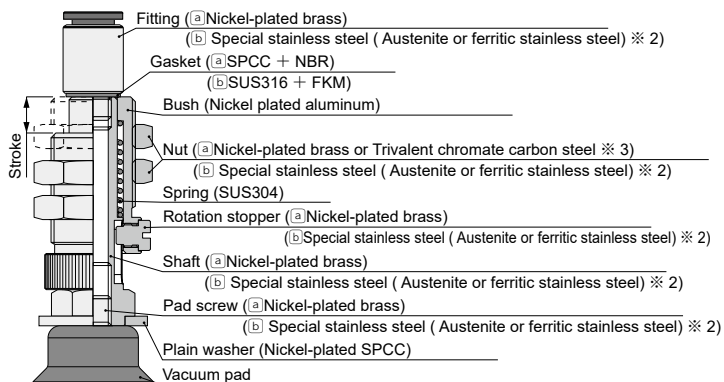

※ 1. (a) : Standard spec. (b) : "-S3" spec.

※ 2. SUS303 equivalent corrosivity

※ 3. Nut material differs depending on the bulkhead thread size. See below table for details.

Bulkhead thread size (mm)	Nut material	
	Nickel-plated brass	Trivalent chromate carbon steel
M5×0.5	○	—
M6×0.75	○	—
M8×0.75	○	—
M10×1	○	—
M12×1	—	○
M14×1	—	○
M16×1	—	○
M20×1	—	○
M22×1	—	○
M24×2	○	—
M30×2	○	—



Safety Instructions

This safety instructions aims to prevent personal injury and damage to properties by requiring proper use of PISCO products.

Be certain to follow ISO 4414 and JIS B 8370.

ISO 4414 : Pneumatic fluid power...General rules and safety requirements for system and their components.

JIS B 8370 : General rules and safety requirements for systems and their components.

This safety instructions is classified into "Danger", "Warning" and "Caution" depending on the degree of danger or damages caused by improper use of PISCO products.



Danger

Hazardous conditions. It can cause death or serious personal injury.



Warning

Hazardous conditions depending on usages. Improper use of PISCO products can cause death or serious personal injury.



Caution

Hazardous conditions depending on usages. Improper use of PISCO products can cause personal injury or damages to properties.



Danger

1. Do not use PISCO products for the following applications.

- ①. Equipment used for maintaining / handling human life and body.
- ②. Equipment used for moving / transporting human.
- ③. Equipment specifically used for safety purposes.



Warning

1. Selection of pneumatic products

- ①. A user who is a pneumatic system designer or has sufficient experience and technical expertise should select pneumatic equipments.
- ②. Due to wide variety of operating conditions and applications for PISCO products, carry out the analysis and evaluation on PISCO products. The pneumatic system designer is solely responsible for assuring that the user's requirements are met and that the application presents no health or safety hazards. All designers are required to fully understand the specifications of PISCO products and constitute all systems based on the latest catalog or information, considering any malfunctions.

2. Usage environment

Do not use PISCO products under the following conditions.

- ①. Beyond the specifications or conditions stated in the catalog, or the instructions.
- ②. Use at outdoors
- ③. Excessive vibrations and impacts.
- ④. Exposure / adhere to corrosive gas, flammable gas, chemicals, seawater, water and vapor.

3. Handling of product

- ① .Handle the pneumatic equipment with enough knowledge and experience.
Mishandling of compressed air is dangerous. A person having enough knowledge and experiences should carry out assembly, operation, and maintenance of devices equipped with pneumatic equipments.
- ② .Do not operate machine / equipment or remove pneumatic equipment until safety is confirmed.
 - (1) .Make sure that preventive measures against falling work-pieces or sudden movements of machine are completed before inspection or maintenance of these machine.
 - (2) .Make sure the above preventive measures are completed. A compressed air supply and the power supply to the machine must be off, and also the compressed air in the systems must be exhausted.
 - (3) .Restart the machines with care after ensuring to take all preventive measures against sudden movements.
- ③ .Do not disassemble or modify PISCO products, which affect the performance, function, and basic structure of the product.
- ④ .Take safety measures such as providing a protection cover if there is a risk of causing damages or fire on machine / facilities by a fluid leakage.
- ⑤ .Do not touch the release-ring of a push-in fitting when there is a working pressure. The lock may be released by the physical contact, and tube may fly out or slip out.
- ⑥ .Frequent switchover of compressed air may generate heat, and there is a risk of causing burn injury.
- ⑦ .Avoid any load on PISCO products, such as, a tensile strength, twisting and bending. Otherwise, there is a risk of causing damage to the products.
- ⑧ .Do not use PISCO products for applications where threads or tubes swing / rotate. The product can be damaged in these applications.
- ⑨ .Do not swing or rotate resin body of the products by force. It may damage to the products and cause a fluid leakage.
- ⑩ .Do not supply excessively dry air to products. It may cause malfunction due to a deterioration of rubber parts.
- ⑪ .Do not wash or paint products with water or solvent. Solvent may damage a resin body, or painting may cause malfunction.
- ⑫ .The product incorporating NBR as seal rubber or gasket material has a risk of malfunction caused by ozone crack. Ozone exists in high concentrations in static elimination air, clean-room, and near the high-voltage motors, etc. As a countermeasure, material change from NBR to HNBR or FKM is necessary. Consult with Pisco for more information.
- ⑬ .Do not stand on a product, or put anything on it. It may cause falls, personal injury or damage to the product.

Warranty

When the product produces a trouble, which is caused by our responsibility, we will carry out either one of the following measures immediately.

- ① .Free-of-charge replacement of same product
- ② .Free-of-charge repair of the product at our factory

Disclaimer

- 1.PISCO does not take any responsibility for any incidental or indirect loss, such as production line stop, interruption of business, loss of benefits, personal injury, etc., caused by any failure on use or application of PISCO products.
- 2.When a cause of the trouble/malfunction applies to any of the following items, it is excluded from the coverage of the above warranty.
 - ① .A case by a natural disaster, a fire except our responsibility, the act by the third person/party, the intention or fault of the customer.
 - ② .A case when a product is used out of the specific range or in a method listed in the product catalog or the instruction manual.
 - ③ .A case by the remodeling of the product or by a change of structure, performance, or specifications which PISCO does not involved in.
 - ④ .A case by the event that is unpredictable by the evaluations and the measures at the time on or before the initial delivery.
 - ⑤ .A case caused by the phenomenon that is able to be evaded if your machine or equipment has functions or structures that are comprised in a common sense when this product is incorporated in your machine or equipment.
- 3.The damages caused by the defect of Pisco products shall be covered but limited to the full amount of the PISCO products paid by the customer. Additionally, the above warranty is limited simply to the product itself. The damage induced by the trouble of the product will not be compensated.



Common Safety Instructions for Products in This catalog

Caution

1. An odd noise may be heard when supply pressures are immediately before the peak of vacuum levels. The sounding of this odd noise means the characteristics are unstable and the sound may become even noisier. This situation can also adversely affect the sensor, resulting in a malfunction or trouble. So reset the supply pressure.
※ Pressure range in which odd noise occurs is affected by atmospheric pressure.
2. Piping design and equipment selection should be made with an effective sectional area on supply pressure side of a vacuum generator being 3 times as large as the nozzle diameter as a standard. Insufficient air flow may impair the performance of the product.
3. Do not use a lubricator on products.
4. Clean or replace silencer element periodically. There is a possibility of dropping the performance or causing troubles by clogging on the element.
5. Keep products away from water, oil drops or dusts because they are neither drip-proof nor dust-proof. Otherwise there is a possibility of causing malfunction, damage to the products, or dropping the performance.
6. Piping
 - ①. Compressed air contains a volume of drain (water, oxidized oil, tar and foreign material, etc.) Because the drain reduce product performance remarkably, dehumidify air with an aftercooler and a dryer, and improve the air quality.
 - ②. Do not use a lubricator on products.
 - ③. Rust in pipe and inflow of foreign substances cause the trouble, malfunction, and degradation of the product. Please install a filter (5 μ m or better filtration) in the compressed air supply line right in front of the product. The flushing inside the pipe before use and in certain intervals is recommended.
 - ④. Remove dusts or drain before piping. They may get into the peripheral machine / facilities and cause malfunction.
 - ⑤. When inserting an ultra-soft tube into push-in fitting, make sure to place an Insert Ring into the tube edge. There is a risk of causing the escape of tube and a fluid leakage without using an Insert Ring.
 - ⑥. Arrange piping avoiding any load on fittings and tubes such as twist, tensile, moment load, shaking and physical impact. These may cause damages to fittings, tube deformations, bursting and the escape of tubes.
 - ⑦. Install protective cover when using at a place getting the direct sunlight.
 - ⑧. Be sure to confirm each port of a vacuum generator with its appearance drawing or the marking on it before piping. Incorrect piping has a risk of damaging the product.
 - ⑨. Plumb a pressure sensor and a vacuum generator with pressure sensor at the end of vacuum system as much as possible. A long distance between a pressure sensor and a vacuum system end may increase plumbing resistance which may lead to a high vacuum level at the sensor even when no suctioning and a malfunction of pressure sensor. Make sure to evaluate the products in an actual system.
 - ⑩. A Shorter distance of plumbing with a wider bore is preferable at vacuum system side. A long plumbing with a small bore may result in slow response time at the time of releasing work-piece as well as in failure to secure adequate suction flow rate.

- ⑪. In case of using non-PISCO brand tubes, make sure the tolerance of the outer tube diameter is within the limits of Table 1.

●Table 1. Tube O.D. Tolerance

mm size	Nylon tube	Polyurethane tube	inch size	Nylon tube	Polyurethane tube
ø1.8mm	—	±0.05mm	ø1/8	±0.1mm	±0.15mm
ø2mm	—	±0.05mm	ø5/32	±0.1mm	±0.15mm
ø3mm	—	±0.15mm	ø3/16	±0.1mm	±0.15mm
ø4mm	±0.1mm	±0.15mm	ø1/4	±0.1mm	±0.15mm
ø6mm	±0.1mm	±0.15mm	ø5/16	±0.1mm	±0.15mm
ø8mm	±0.1mm	±0.15mm	ø3/8	±0.1mm	±0.15mm
ø10mm	±0.1mm	±0.15mm	ø1/2	±0.1mm	±0.15mm
ø12mm	±0.1mm	±0.15mm	ø5/8	±0.1mm	±0.15mm
ø16mm	±0.1mm	±0.15mm			

7-1. Tube insertion (Push-in fitting)

- ①. Make sure that the cut end surface of the tube is at a right angle without a scratch on the tube surface or deformations.
- ②. When inserting a tube, the tube needs to be inserted fully into the push-in fitting until the tubing edge touches the tube end of the fitting as shown in the figure below. Otherwise, there is a risk of leakage.

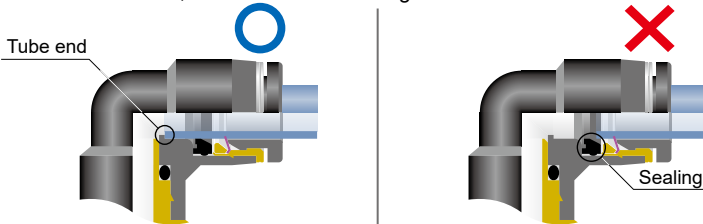

Tube is not fully inserted up to tube end.

- ③. After inserting the tube, make sure it is inserted properly and not to be disconnected by pulling it moderately.
 - ※ When inserting tubes, Lock-claws may be hardly visible in the hole, observed from the front face of the release-ring. But it does not mean the tube will surely escape. Major causes of the tube escape are the followings; ① Shear drop of the lock-claws edge ② The problem of tube diameter (usually small) Therefore, follow the above instructions from ① to ③, even lock-claws is hardly visible.

7-2. Tube insertion (Compression fitting)

- ①. Make sure that the cut end surface of the tube is at a right angle without deformations or a scratch on its inner and outer surface.
- ②. Pass the tube through the nut and insert the barb into the tube up to the barb end. Then tighten the hexagonal-column of the nut with a proper tool.
- ③. Refer to Table 2 which shows the tightening torque.
 - ※ Hold the tube when tightening the nut, since the tube may rotate along with the nut.

- ④. Make sure that the nut touches the metallic body. If not, loosen the nut, disconnect the tube and start over again from the process ①
- ⑤. Make sure that there is no leakage after tightening the nut.
- ⑥. After inserting the tube, make sure it is inserted properly and not to be disconnected by pulling it moderately.

● Table 2. Nut tightening torque

Tube O.D.	Tightening torque
ø10	Max. 4N·m
ø12	Max. 5N·m
ø16	Max. 14N·m

8-1. Tube disconnection (Push-in fitting)

- ①. Make sure there is no air pressure inside of the tube, before disconnecting it.
- ②. Push the release-ring of the push-in fitting evenly and deep enough to pull out the tube toward oneself. By insufficient pushing of the release-ring, the tube may not be pulled out or damaged by scratch, and tube shavings may remain inside of the fitting, which may cause the leakage later.

8-2. Tube disconnection (Compression fitting)

- ①. Make sure there is no air pressure inside of the tube, before disconnecting it.
- ②. Use a proper tool to loosen the nut. Then disconnect the tube.

9. Installation of a fitting

- ①. When installing a fitting, use proper tools to tighten a hexagonal-column or an inner hexagonal socket. When inserting a hex key into the inner hexagonal socket of the fitting, be careful so that the tool does not touch lock-claws. The deformation of lock-claws may result in a poor performance of systems or an escape of the tube.
- ②. Refer to Table 3 in the next page which shows the tightening torque, when tightening a thread. Do not exceed these limits to tighten a thread. Excessive tightening may break the thread part or deform the gasket to cause a fluid leakage. Tightening thread with tightening torque lower than these limits may cause a loosened thread or a fluid leakage. Since the sealability is affected by the processing condition of the installing part, adjust the tightening torque or correct the installing part, according to the condition.
- ③. Adjust the tube direction while tightening thread within these limits, since some PISCO products are not rotatable after the installation.

● Table 3. Tightening torque / Sealock color / Gasket materials

Thread type	Thread size	Tightening torque	Sealock color	Gasket material
Metric thread	M3×0.5	0.7N·m	n/a	SUS304+NBR SPCC+NBR
	M5×0.8	1 ~ 1.5N·m		
	M6×1	2 ~ 2.7N·m		
	M3×0.5	0.7N·m		POM
	M5×0.8	1 ~ 1.5N·m		
	M6×0.75	0.8 ~ 1N·m		
Taper pipe thread	M8×0.75	1 ~ 2N·m	White	—
	R1/8	4.5 ~ 6.5N·m		
	R1/4	7 ~ 9N·m		
	R3/8	12.5 ~ 14.5N·m		
Unified thread	R1/2	20 ~ 22N·m	n/a	SUS304+NBR, SPCC+NBR
	No. 10-32UNF	1 ~ 1.5N·m		
National Pipe Thread Taper (American standard)	1/16-27NPT	4.5 ~ 6.5N·m	White	—
	1/8-27NPT	4.5 ~ 6.5N·m		
	1/4-18NPT	7 ~ 9N·m		
	3/8-18NPT	12.5 ~ 14.5N·m		
	1/2-14NPT	20 ~ 22N·m		
G thread	G1/4	12 ~ 14N·m	n/a	Aluminum + PBT
	G3/8	22 ~ 24N·m		
	G1/2	28 ~ 30N·m		

※ These values may differ for some products. Refer to each specification as well.

- ④ When removing a fitting, use proper tools to loosen a hexagonal-column. When inserting a hex key into the inner hexagonal socket of the fitting, be careful so that the tool does not touch lock-claws. The deformation of lock-claws may result in a poor performance of systems or an escape of the tube.
- ⑤ Remove the sealant stuck on the mating equipment. The remained sealant may get into the peripheral equipment and cause malfunctions.

10. Handling of PISCO products

- ① Impact caused by dropping or the like may lead to damage to the product and a fluid leakage.

11. PISCO products shall be used within the Operating temp. range, including the heat of the product itself generated by adiabatic compression.