

DF

Magnetic and Electronic proximity sensor

Sensors assembled on cylinders detect the position of the piston by switching an electric signal when the magnetic field, produced by the magnet in the piston, is approaching. Available in two different types: electromechanical with Reed bulb and electronic with magnetoresistive effect both in NO version with PNP output and NC version with NPN output.

The Reed bulb type normally works in both direct and alternating current while the electronic type works in direct current only (max 30V DC).

Available ATEX version upon request

CE II 3 GD c nA II T5 -10°C ≤ Ta ≤ 45°C

For types and versions, see ATEX catalogue



TECNICAL CHARACTERISTICS

Type	ELECTROMECHANICAL REED			ELECTRONIC PNP
	DF-220	DF-330	DF-440	DF-770
Part no.				
Working voltage (V AC/DC)	5÷30 V AC/DC	5÷30 V AC/DC	5÷30 V AC/DC	5÷30 V DC
Max switching current (mA)	100	100	100	100
Max switching power (W/VA)	3	3	3	3
Max voltage drop (V AC/DC)	<3,5	0,1	0,1	0,7
Minimum magnetic field (gauss)	60	60	60	30
Opening response time (ms)	< 0,5	< 0,5	< 0,5	0,08
Closing response time (ms)	< 1	< 1	< 1	0,03
Electric life with resistive load (cycles)	>10 ⁷	>10 ⁷	>10 ⁷	>10 ⁹
State indicator (LED)	red	red	red	red
Cable number and section (mmq)	2x0,14	3x0,14	3x0,14	3x0,14
Cable length (mm)	3000	3000	3000	3000
Electric circuit	A	C	D	C
Protection degree (EN60529)	IP67			
Working temperature (°C)	-20 ÷ +80			

OTHER VERSIONS AVAILABLE

With NPN 3m cable	DF-330NPN (ref. electrical circuit E)			
With 5m cable	DF-220L5		DF-330L5	
With 10m cable	DF-220L10		DF-330L10	
With 0,2m cable with M08 connector	DF-220M08	DF-330M08	DF-440M08	DF-770M08
With 0,2m cable with M12 connector	DF-220M12	DF-330M12	DF-440M12	DF-770M12
3m ext. cable with M08 3-poles connect.	DHF-033M08			
5m ext. cable with M08 3-poles connect.	DHF-053M08			
3m ext. cable with M12 3-poles connect.	DHF-033M12			
5m ext. cable with M12 3-poles connect.	DHF-053M12			
Cable clamping	DF-001			

When using the M08 and M12 3-poles extension cable with DF-220 magnetic sensors, exclude the blue wire before connection.

Make sure to correct the polarity connection while using direct current; avoid magnetic fields influencing the electronic sensor; install the KM-008200 protection filter in case of use of extension cables longer than 10m; install dedicated filters in case of inductive loads.

Subject to change

Dimensions

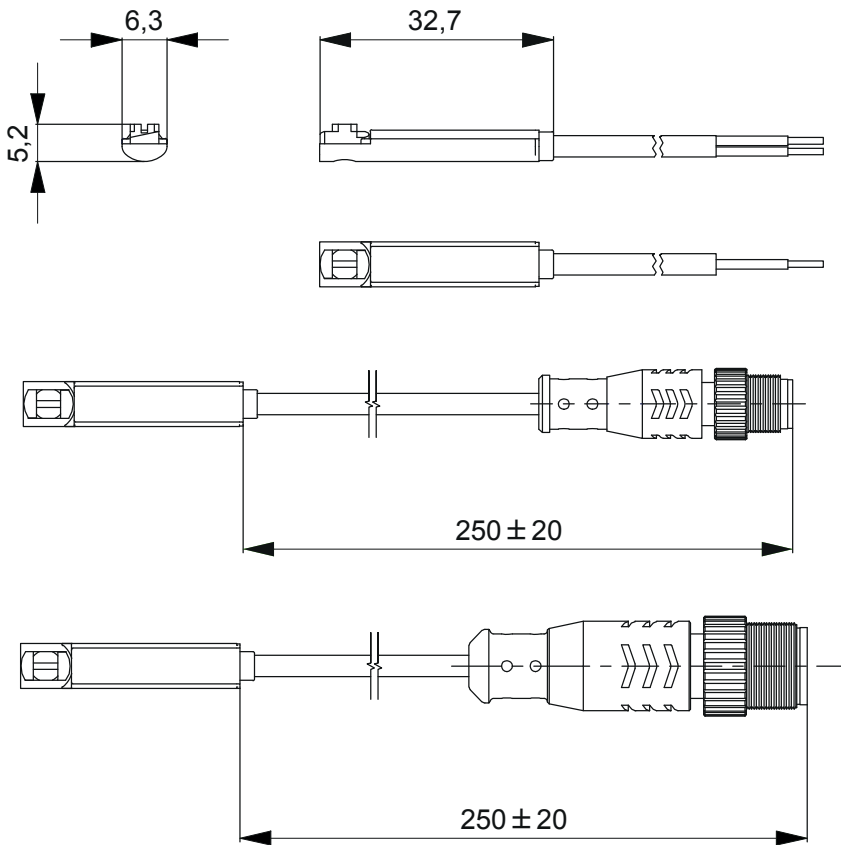

Fixing bracket for M series cylinders

5

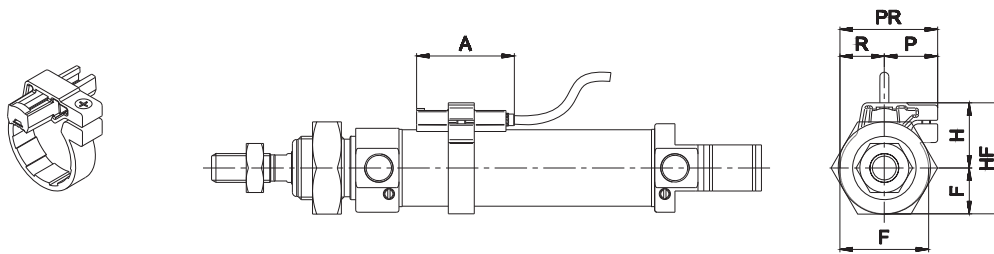

Material: body: polycarbonate
screw: chromium-plated steel

Ø	A	F	H	HF	P	R	PR	Part no.
10	34	8	17	25	15	8	23	DH-M10DF
12	34	8	17	25	15	8	23	DH-M12DF
16	34	11	18	29	17	11	28	DH-M16DF
20	34	12	20	32	17	12	29	DH-M20DF
25	34	16	23	39	19	16	35	DH-M25DF

DF sensor cable clamping

DF sensor covering strip

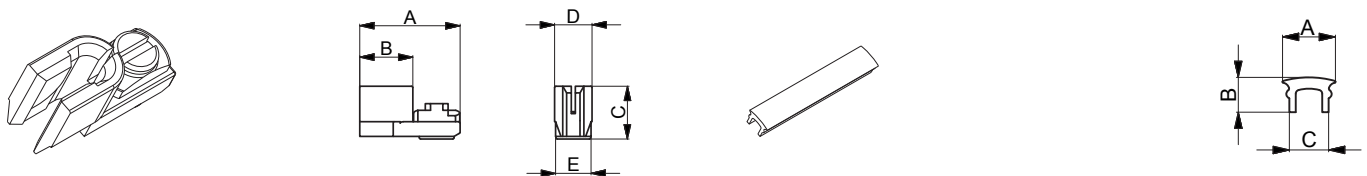

Material: body: polycarbonate
screw: chromium-plated steel

A	B	C	D	E	Part no.
15	7,8	7,9	5,8	5,5	DF-001

Material: pvc

A	B	C	Part no.
7	4,6	5,2	DHF-002010

Electrical Circuit

Version with cable

A AC/DC 2 wires NO

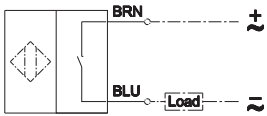

C DC 3 wires PNP NO

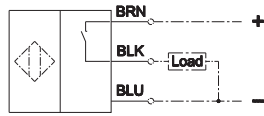

D DC 3 wires PNP NC

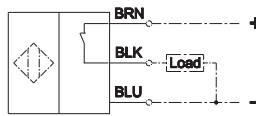

E DC 3 wires PNP NC

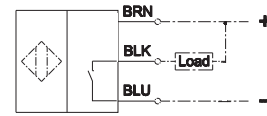

BRN = Brown
BLK = Black
BLU = Blue

Version with connector

A AC/DC 2 wires NO

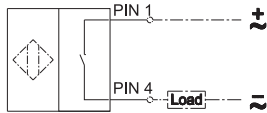

C DC 3 wires PNP NO

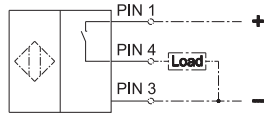

D DC 3 wires PNP NC

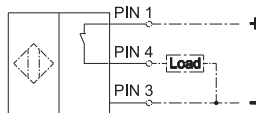

E DC 3 wires PNP NC

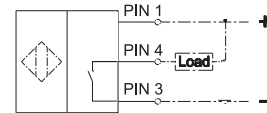

PIN 1 = Brown
PIN 2 = White
PIN 3 = Blue
PIN 4 = Black

M08 2 wires

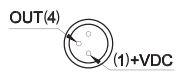

M12 2 wires



M08 3 wires



M12 3 wires

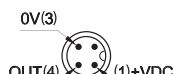

Assembly scheme

1

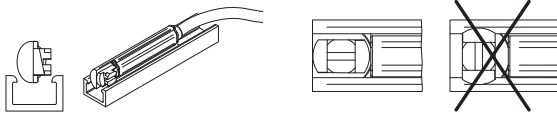

Put the sensor in the proper groove and make sure that the fastening plate has the slot for screwdriver along the sensor axis.

2

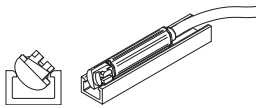

Put the sensor inside its groove and make sure that the fastening plate is on the open part of the groove.

3

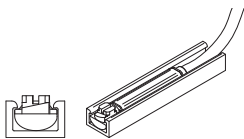

Check the correct position of the sensor in the groove. Turn it to the wished position for detection.

4

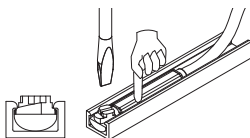

Keep the sensor in its position and screw the fastening plate to fix the sensor in the groove.
Max torque: 0,5 ÷ 1 Nm