

MAR200 series

AIR UNIT (R.UNIT)

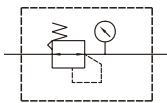

Symbol



Specification

Model	MAR200	
Bore No.	6A	8A
Port size	1/8	1/4
Medium	Air	
Max. operating pressure	1 MPa	
Proof pressure	1.5 MPa	
Regulated pressure range	Standard type: 0.05~0.85 MPa	
Ambient temperature	-5~+60°C (No freezing)	
Attachment	L-type bracket	
Option	Pressure gauge (PG-40)	
Weight	190 g	

Order example

MAR200 - 6A - 1K - C - □ - □

MODEL

PORT SIZE

6A: 1/8
8A: 1/4

ADJUSTABLE PRESS. RANGE

Blank: 0.05~0.85 MPa
1K: 0.05~0.1 MPa
2K: 0.05~0.2 MPa
3K: 0.05~0.3 MPa
4K: 0.05~0.4 MPa

BRACKET

Blank: L type
B3: Z type

PORT THREAD

Blank: Rc thread
G: G thread
NPT: NPT thread

C: Pressure gauge (PG-40)

Flow feature

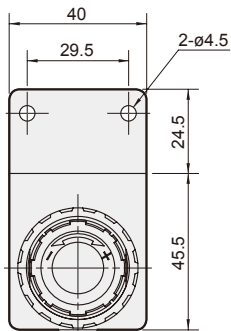
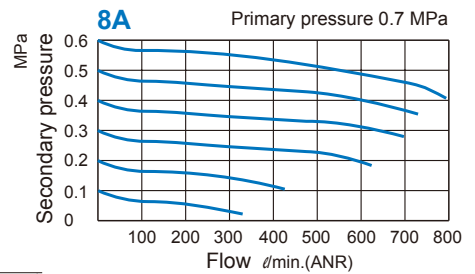
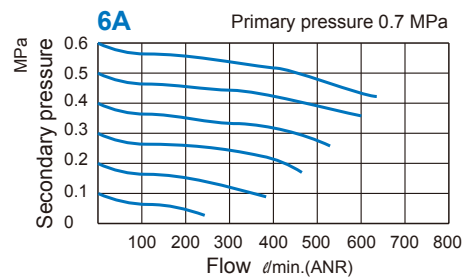

Panel mounting hole

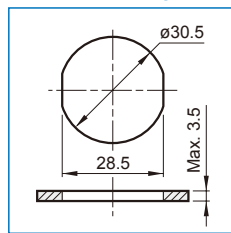

Z type bracket

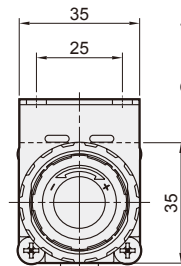
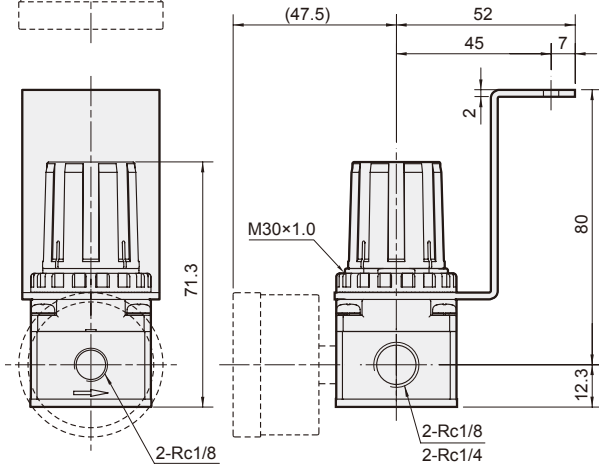

L type bracket

