

MAF403 A / D / M series

AIR UNIT (AIR / MIST / MICRO MIST FILTER)

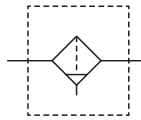

Symbol



A: 5µm

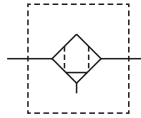

D: 0.3µm

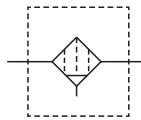

M: 0.01µm

- MAF403A is designed for draining and removal of foreign matter. (Element: 5µm)
- MAF403D/M is designed for removal of foreign matter as well as oil mist (Element: 0.3µm / 0.01µm)

Specification

Model	MAF403A/D/M		
Bore No.	8A	10A	15A
Port size	1/4	3/8	1/2
Medium	Air		
Operating pressure range (*)	0.05~1 MPa		
Proof pressure	1.5 MPa		
Ambient temperature	- 5~+60°C (No freezing)		
Filter element	5 µm, 0.3 µm, 0.01 µm		
Drain capacity	75 cm ³		
Weight	345 g		

* Standard unit contains semi-auto-drain function when operating pressure below 0.05 MPa.

* Choose auto-drain FMRF300, the pressure range is 0.15~1 MPa.

Order example

MAF403 D-8A-ND□-B-□

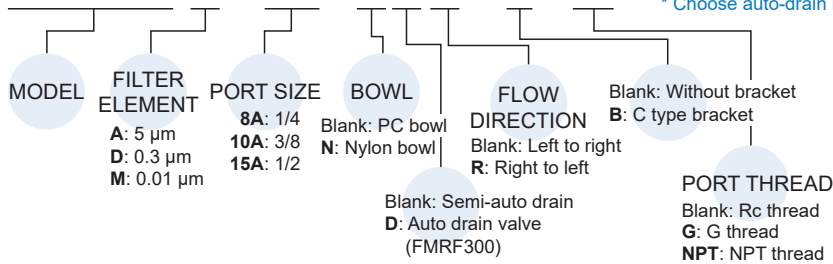

Option accessories

C type bracket

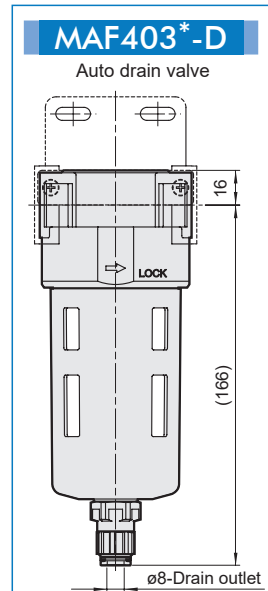
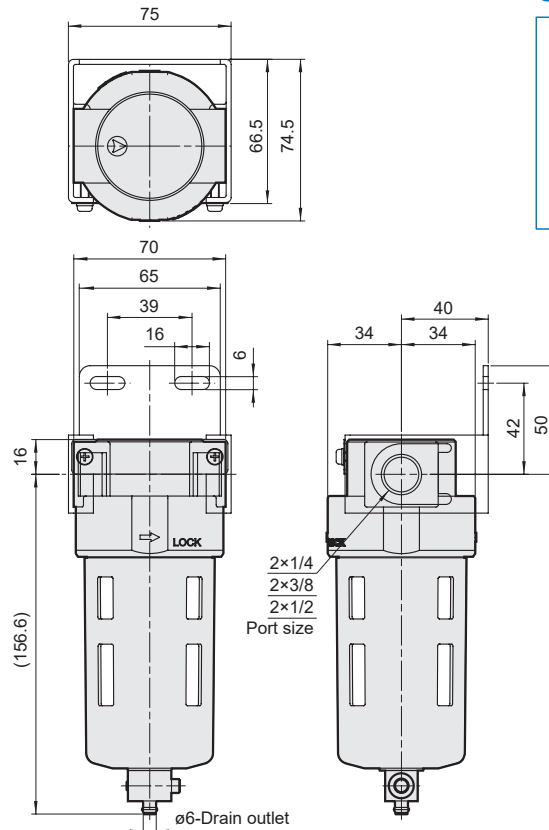
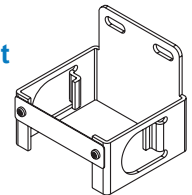

MAF403 A / D / M Capacity

AIR UNIT (AIR / MIST / MICRO MIST FILTER)



mindman

Flow feature

MAF403A (Filter element: 5 μm)

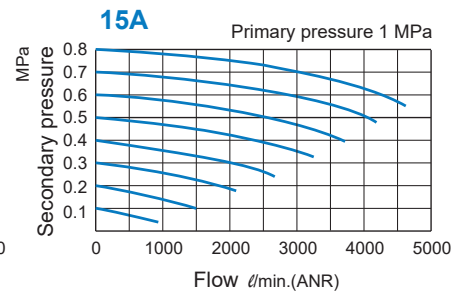
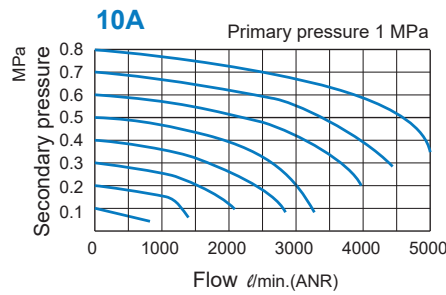
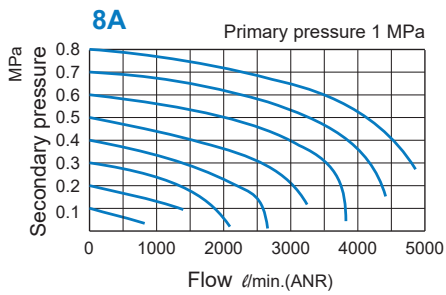

MAF403D (Filter element: 0.3 μm)

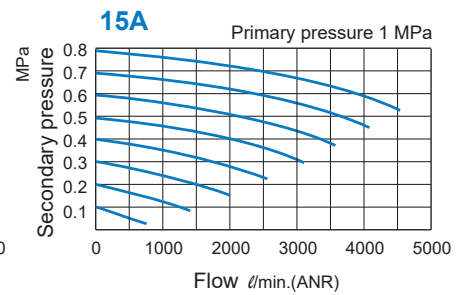
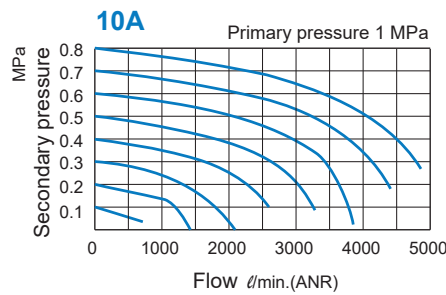
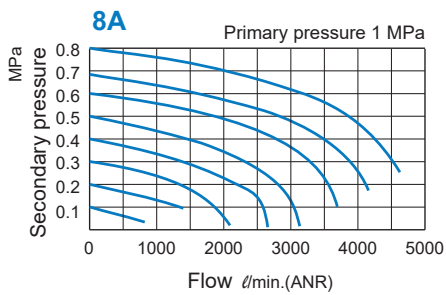

MAF403M (Filter element: 0.01 μm)

